



Quick Manual
confocalDT 2411
EtherCAT

IFD2411-1
IFD2411-2
IFD2411-3
IFD2411-6

Contents

General	3
Symbols Used	3
Warnings	3
Intended Use	4
Proper Environment	4
Glossary	4
Mechanical Fastening Sensor	5
Preliminary Remarks	5
Circumferential Clamping	5
Mechanical Fastening Controller	6
Start of Measuring Range	6
Electrical Connections	7
Supply Voltage	8
Synchronization, Trigger	8
RS422 Connection with USB Converter IF2001/USB	9
Sensor LEDs	9
Multifunction Button	10
Sensor Cable, Optical Fiber	11

MICRO-EPSILON
MESSTECHNIK
GmbH & Co. KG
Koenigbacher Str. 15

94496 Ortenburg / Germany

Tel. +49 (0) 8542 / 168-0
Fax +49 (0) 8542 / 168-90
e-mail info@micro-epsilon.com
www.micro-epsilon.com



EtherCAT® is registered trademark
and patented technology, licensed by
Beckhoff Automation GmbH, Germany.

You can find more information about the measuring system
in the operating instructions. They are available online at:

[www.micro-epsilon.de/download/manuals/man-
confocalDT-2410-2411-2415--en.pdf](http://www.micro-epsilon.de/download/manuals/man-confocalDT-2410-2411-2415--en.pdf)

Initial Operation	12
Switch between EtherCAT and Ethernet Setup Mode	13
Access via Web Interface	14
Positioning the Target	15
Presets, Setups, Measurement Configuration, Signal Quality ...	16
Checking the Video Signal, Peak Selection	18
Distance Measurement with Website Display	19
One-Sided Thickness Measurement, Transparent Target	21
Preset Selection	21
Material Selection	21
Video Signal	22
Measurement Chart for Thickness Measurement	23
Switch between Ethernet Setup Mode and EtherCAT	24
EtherCAT	25
Preliminary Remarks	25
Parameter Setting via EtherCAT	25
Saving the Settings, Continuing EtherCAT Mode	26
Service, Repair	27
Disclaimer	27
Decommissioning, Disposal	28



General

Symbols Used

The following symbols are used in this document:



Indicates a hazardous situation which, if not avoided, may result in minor or moderate injury.



Indicates a situation that may result in property damage if not avoided.



Indicates a user action.



Indicates a tip for users.

Measurement

Indicates hardware or a software button/menu.

Warnings



Connect the power supply and the display/output device according to the safety regulations for electrical equipment.

> Risk of injury, damage to or destruction of the controller

When all interfaces are used, the controller heats up to more than 50 °C.

> Risk of injury



Avoid shocks and impacts to the sensor and controller.

> Damage to or destruction of the sensor and/or controller

The supply voltage must not exceed the specified limits.

> Damage to or destruction of the sensor and/or controller

Protect the cables against damage.

> Failure of the measuring device

Intended Use

- The measuring system is designed for use in an industrial environment. It is used for
 - displacement, distance, movement and thickness measurement,
 - measuring the position of parts or machine components
 - The measuring system must only be operated within the limits specified in the technical data.
- The measuring system must only be used in such a way that no persons are endangered or machines are damaged in the event of malfunction or total failure of the controller.
- Take additional precautions for safety and damage prevention in case of safety-related applications.

Proper Environment

	Sensor	Controller
Protection class	IP64, front side	IP40
Operating temperature range	+5 ... +70 °C	+5 ... +50 °C
Temperature range (storage)	-20 ... +70 °C	
Humidity	5 ... 95 % (non-condensing)	
Ambient pressure	Atmospheric pressure	
Shock (DIN-EN 60068-2-27)	15 g / 6 ms in XY-axis, 1000 shocks each	
Vibration (DIN-EN 60068-2-6)	2 g / 20 ... 500 Hz in XY-axis, 10 cycles each	

Glossary

SMR Start of measuring range

MMR Mid of measuring range

MR Measuring range

EMR End of measuring range

Minimum target thickness see Technical Data, Operating Instructions

Maximum target thickness Sensor measuring range x Refractive index of target

Mechanical Fastening Sensor

Preliminary Remarks

The optical sensors operate in the nanometer range. Observe the maximum tilt angle between sensor and target.

- Ensure careful handling during installation and operation!

Circumferential Clamping

- Use an installation bracket MA240x to mount IFS2404-1 / 3 / 6 sensors.



Mounting ring	Size A	Size B	Size C	
MA2400-27	ø27	ø46	19.75 (.78)	

Mounting ring MA2400-27

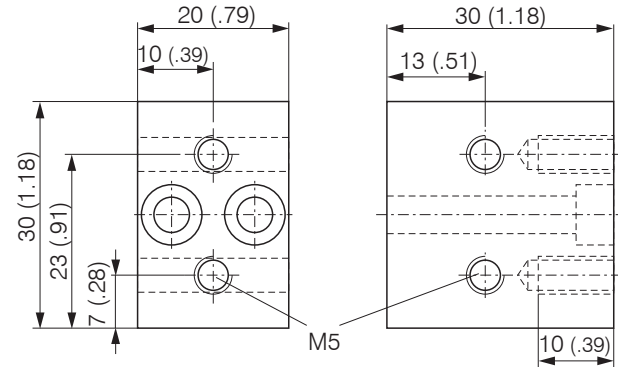

Mounting block MA240x

- Use an installation bracket MA2404-12 to mount IFS2404-2 sensors.

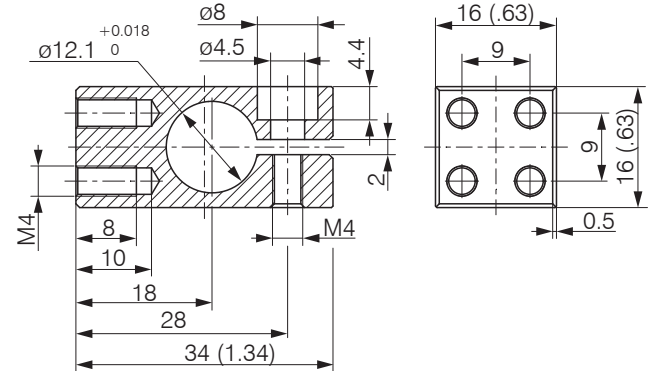

Montageblock MA2404-12

Mechanical Fastening Controller

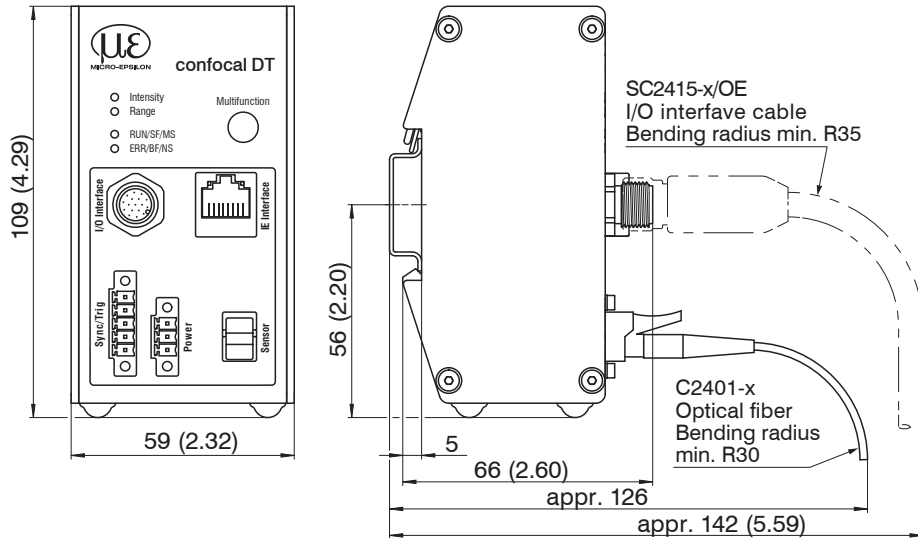

The IFC2411 controller can be mounted, e.g., in a control cabinet using a top-hat rail TH 35 according to DIN EN 60715.

i When attaching the controller, ensure that no connections, operating or display elements are covered.

Dimensional drawing IFC2411, dimension in mm (inch)

Start of Measuring Range

A start of measuring range (SMR) between the sensor and the target must be kept.

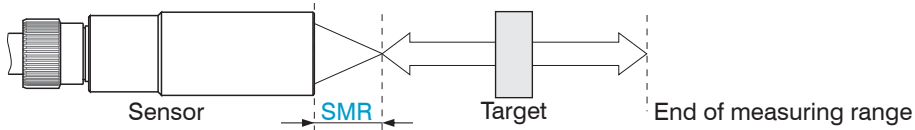

Start of measuring range (SMR), the shortest distance between the front surface of the sensor and the target

Electrical Connections

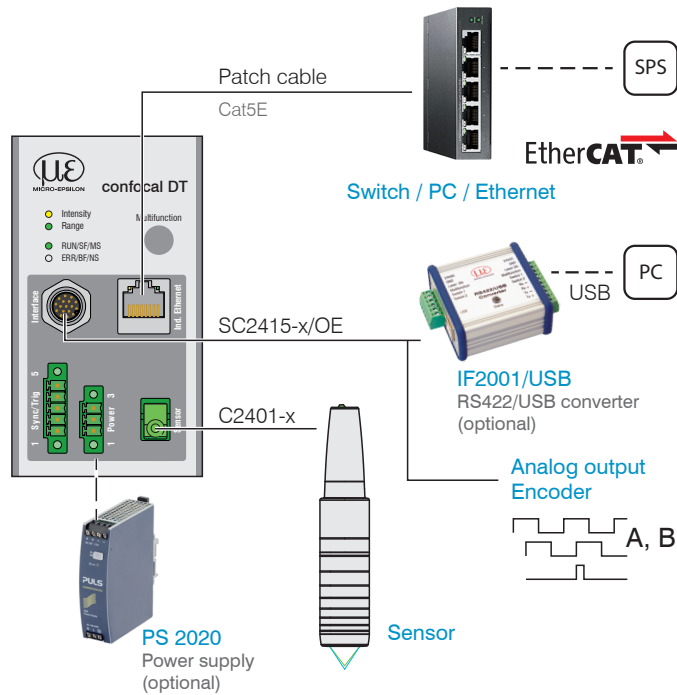

Characteristics SC2415-x/OE signal line:

- Analog output
- RS422
- Encoder

The SC2415-x/OE cable is not included in delivery.

17-pin male connector controller		SC2415-x/OE
Signal	Pin	Wire color
Analog output	1	white, internal
Analog GND	2	black ¹
Data Tx-	3	black
Data Tx+	13	purple
n.c.	5	red
n.c.	14	blue
Encoder 1B+	8	grey
Encoder 1B-	15	pink
Encoder 1Ref+	9	green
Encoder 1Ref-	16	yellow
Data Rx+	10	brown
Data Rx-	11	white
Encoder 1A-	12	red/blue
Encoder 1A+	17	grey/pink

Pin assignment SC2415-x/OEY

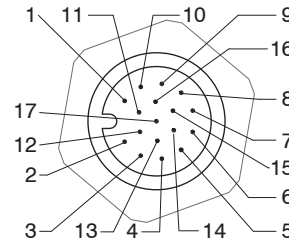

The GND connections are not electrically separated.

17-pin controller male connector, pin side

1) Analog output in shielded cable area

Supply Voltage

Nominal value: 24 V DC (20 ... 28 V, $P < 7 \text{ W}$)

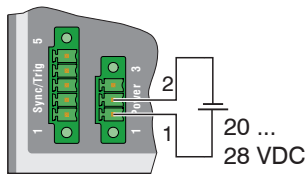

Controller	Power supply
3-pin pluggable screw terminal	
1	V_+
2	GND
3	Screen

Voltage supply only for measuring devices, not to be used for drives or similar sources of impulse interference at the same time. MICRO-EPSILON recommends using an optional available power supply unit PS2020 for the sensor.

- ➡ Only turn on the power supply after wiring has been completed.
- ➡ Connect the inputs Pin 1 and Pin 2 at the sensor with a 24V power supply.

Synchronization, Trigger

- ➡ Interconnected all GND, if the controllers are not supplied from a common power supply.

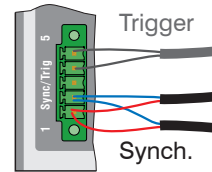

Controller	Signal	Level
5-pol pluggable screw terminal		
1	Sync +	RS422
2	Sync -	RS422
3	Kabel shield	
4	Trig	TTL
5	GND	

Star- or Cascaded synchronization

- ➡ Connect Pins 1 and 2 of controller 1 (master) with the correct polarity to Pins 1 and 2 of controller 2 (slave) to controller n, in order to synchronize two or more controllers.

Triggering

- ➡ Connect the pins 4 and 5 with a trigger source (master).

RS422 Connection with USB Converter IF2001/USB

In addition to Industrial Ethernet, the controller also supports serial communication via RS422. Serial communication is possible with PC2415-x/OE cables. The PC2415-x/OE cable and the IF2001/USB RS422-to-USB converter are an optional accessory.

Properties: Differential signals according to EIA-422, galvanically connected to the supply voltage.

- Use a shielded cable with twisted wires.
Cable length less than 30 m.
- Connect the ground connections.

Controller 17-pin connector	Signal	SC2415-x/OE	IF2001/USB
3	TX -	black	RX -
13	TX +	purple	RX +
10	RX +	brown	TX +
11	RX -	white	TX -
Housing	Shield	Cable shield	---

Sensor LEDs

RUN	green	Off	Slave is in the "Init" status
	green	flashes evenly	Slave is in the "Pre-Operational" status
	green	flashes briefly	Slave is in the "Safe-Operational" status
	green	flashes quickly	Slave is in the "initialization" or "bootstrap" status
	green	lights up	Slave is in the "Operational" status
ERR	red	Off	No error
	red	flashes evenly	Invalid configuration
	red	flashes briefly	Unwanted status change
	red	flashes twice	Timeout of the Application watchdog
	red	flickers	Boot error
	red	lights up	Timeout of the PDI watchdog

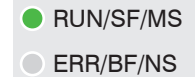

LED	Color	Status	Meaning
Intensity	red	flashes	Dark signal acquisition in progress
	red	lights up	Signal saturated
	yellow	lights up	Signal too low
	green	lights up	Signal OK
Range	red	flashes	Dark signal acquisition in progress
	red	lights up	No target present, outside of measuring range
	yellow	lights up	Target close to mid of measuring range
	green	lights up	Measuring object within the measuring range

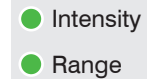

Multifunction Button

The `Multifunction` button is assigned multiple functions. As default, the button is assigned the dark reference function.

Function	Dark reference	<i>Starts dark referencing</i>
	Factory setting	Reset the device and measurement settings to factory settings.

The selected function is indicated by the flashing/illuminated Range and Intensity LEDs.

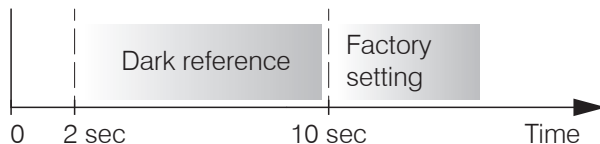

Multifunction *button actuation time*

The `Multifunction` button is not assigned a key lock in the factory. Optionally, you can deactivate or lock the `Multifunction` button, see the operating instructions for the controller. With the `Multifunction` key you can also change the operation mode. For details, refer to section `Initial Operation` or `Switch between EtherCAT and Ethernet Setup Mode`.

Sensor Cable, Optical Fiber

Sensor and controller are connected through an optical fiber.

- Do not shorten or lengthen the optical fibers.
- Do not pull or hold the sensor on the optical fiber.

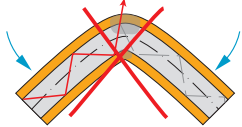

Do not kink the sensor cable.

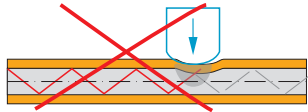

Please do neither squeeze the sensor cable nor fix it by using cable ties.

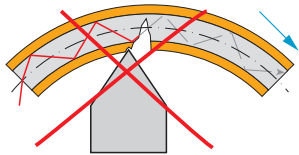

Please do not grind the sensor cable over sharp corners.

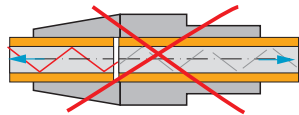

Do not pull the sensor cable.

Cleaning of the connectors requires the corresponding know-how.

Basic Rules

Avoid

- any contamination of the connector, e. g. dust
- any mechanical stress of the fiber
- strong bending of the fiber

Please never underrun the allowed bending radius.

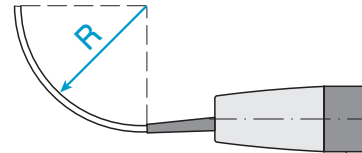

Fixed:
R = 30 mm or more

Flexible:
R = 40 mm or more

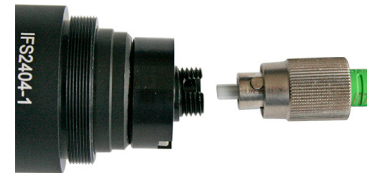

Fiber optic and sensor

i Note the orientation of the socket and the guiding peg.

Socket groove on the sensor (left) and guiding peg of an FC sensor plug (right)

Initial Operation

- The measuring system is ready for operation approx. 3 s after applying the supply voltage.
- ! To ensure precise measurements, let the measuring system warm up for about 50 minutes.

The controller starts in the last stored operating mode. Default is EtherCAT.

Ethernet-Setup-Mode

- Programming via web interface,
- no EtherCAT

➡ Switch to the Ethernet setup mode.

Details can be found in section `Switch between EtherCAT and Ethernet Setup Mode`.

- ➡ Connect the sensor and the PC with a LAN cable.
- ➡ Start your web browser and type the default IP address 169.254.168.150 of the sensor into the address bar.

Alternative communication with the sensor

RS422 Communication

- Programming via web interface;
- programming on command level e.g. with Telnet,
- no parallel output of measurement data via EtherCAT and RS422 possible

➡ Connect the sensor, e.g. via an IF2001/USB RS422 converter from Micro-Epsilon via USB to a PC.

➡ Start the `sensorTOOL` program.

Download at <https://www.micro-epsilon.de/download/software/sensorTOOL.exe>.

➡ Click the `Sensor` button.

The program will now search for connected sensors.

➡ Select a desired sensor. Click the `Open Website` button.

Ethernet over EtherCAT (EoE)

- Programming via web interface;
- programming on command level e.g. with Telnet,
- Parallel programming and measurement

➡ Enable the EoE in your PLC software.

➡ Assign each a virtual MAC address and an IP address to the controller with your EtherCAT master.

Saved settings remain in the sensor remanently across interfaces

Switch between EtherCAT and Ethernet Setup Mode

The controller starts in the last stored operating mode. Factory setting is EtherCAT. Access via Ethernet is possible in the Ethernet setup mode.

➡ Press and hold the Multifunction button on the controller before switching on the power supply on the sensor. Release the button again as soon as the Intensity LED flashes yellow. Press the button again for approx. 10 to 15 seconds until the Intensity LED flashes red.

Within the time $t_2 \dots t_3$, the red flashing with 8 Hz starts after 10 seconds. The key must be released again after 15 seconds at the latest. When the Multifunction key is released at the latest at time t_3 , the Intensity LED starts to flash yellow at 8 Hz.

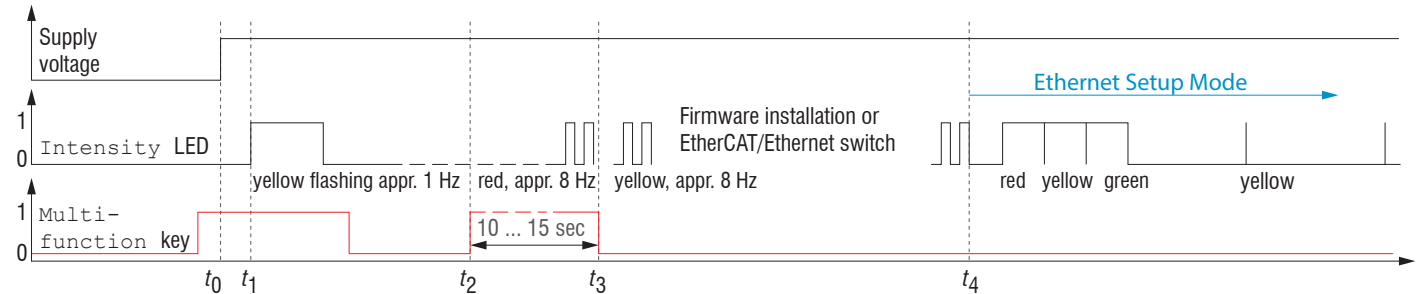

Flowchart for starting a controller in Ethernet setup mode

After completion of the firmware installation/switch, the controller reboots at time t_4 .

t_0 : Supply voltage is applied

t_1 : The Intensity LED starts flashing yellow, the Multifunction button can be released

t_2 : Within 15 sec. ($t_2 - t_1$), press Multifunction button again and hold for further 10 ... 15 sec. ($t_3 - t_2$)

$t_3 \dots t_4$: Switches from EtherCAT to Ethernet Setup Mode, duration max. 1 min.

t_4 : Controller starts in Ethernet setup mode, the Intensity LED lights up briefly at intervals of approx. 1 sec.

Access via Web Interface

▶ Start the web interface of the controller, see section *Initial Operation*.

Interactive web pages you can use to configure the controller are now displayed in the web browser. The controller is active and supplies measurement values. The web interface does not guarantee real-time measurements. The currently running measurement can be controlled using the function buttons in the Chart type section.

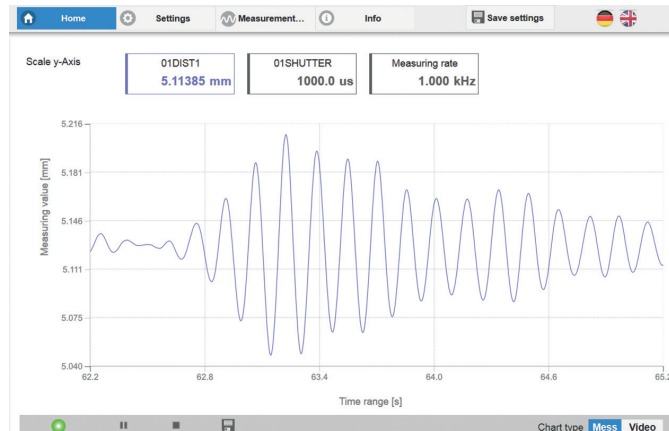

First page after web interface has been accessed in Ethernet mode

For configuration, you can switch between the video signal and a display of the measured values over time. The appearance of the websites depends on the functions. Dynamic help texts with excerpts from the operating instructions supports you during controller configuration.

• Depending on the selected measuring rate and the PC used, measured values may be reduced in the display. That is, not all measured values are transmitted to the web interface for display and saving.

The horizontal navigation includes the functions below:

- Home. The web interface automatically starts in this view with Measurement Chart, Measurement configuration and Signal quality.
- Settings. Sensor parameters configuration such as triggering, measuring rate and zero setting/mastering.
- Measurement chart. Measurement chart or video signal display.
- Info. Includes information about the controller, such as measuring range, serial number and software status.

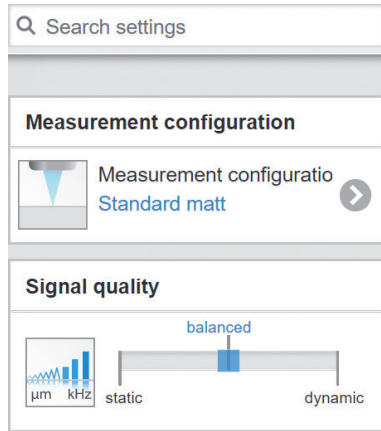

The vertical navigation is contextual to the selection in the horizontal navigation and contains the following functions for the Home menu:

- The `Search settings` function permits time-saving access to functions and parameters.
- `Measurement configuration`. Allows a selection of predefined measurement settings.
- `Signal quality` By mouse click it is possible to switch between three predefined basic settings for the measuring rate and the averaging.

Positioning the Target

➡ Position the target as centrally as possible within the measuring range.

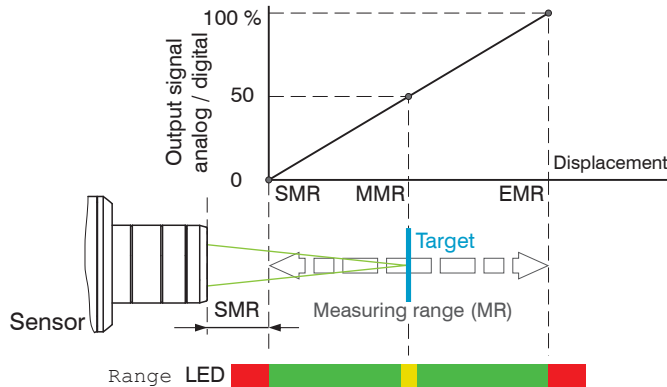

- intensity
- range

Range LED	
Red	No target present or target outside of measuring range
yellow	Target close to mid of measuring range
green	Measuring object within the measuring range

The Range LED on the front of the controller indicates the position of the target relative to the sensor.

Presets, Setups, Measurement Configuration, Signal Quality

Definition

- Preset: Manufacturer-specific program with settings for frequent measurement tasks; cannot be overwritten
- Setup: User-specific program with relevant settings for a measurement task
- Initial setup at boot (controller start): a favorite can be selected from the setups, which is automatically activated at controller start. If no favorite is determined from the setups, the controller activates the **Standard** preset at startup.

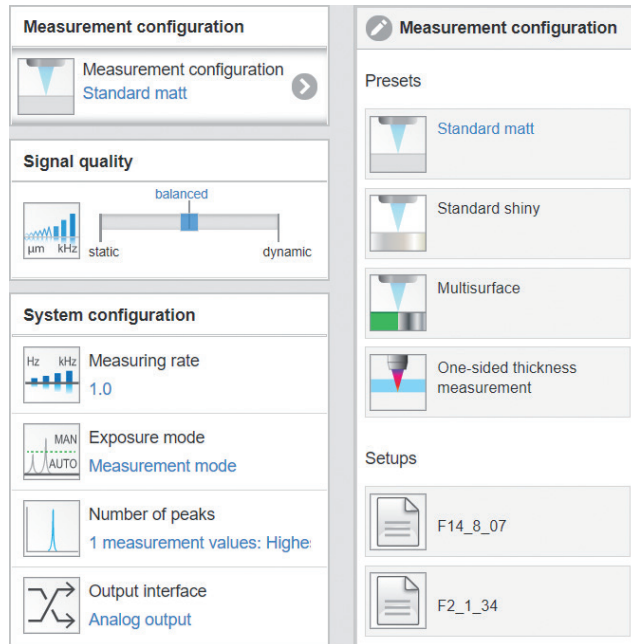

Upon delivery of the controller from the factory

- the presets **Standard**, **Standard shiny**, **Multisurface** and **One-sided thickness measurement** are possible
- for the IFD2415 sensor, the presets **Multilayer air gap** and **Multilayer composite material** are available.
- no setup is available.

You can select a preset in the tab

Home > Measurement configuration

You can select a setup in the tab

Home > Measurement configuration or Settings in the System settings > Load & save menu

A setup can be stored permanently in the controller.

For all presets, the measurement task can be individually adapted via the `Signal quality` slider. Reducing the measuring rate increases the exposure time for the line and thus improves the measurement quality.

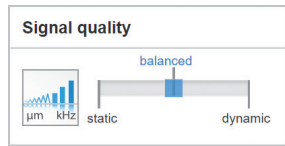

Measuring rate	Averaging ¹	Description
0.2 kHz	Static Moving, 128 values	Three predefined basic settings (Static, Balanced and Dynamic); a change via mouse click is immediately visible in the diagram and the system configuration.
1 kHz	Balanced Moving, 16 values	
5 kHz	Dynamic Moving, 4 values	i If the controller starts up with a user-defined measurement setting (setup), the signal quality cannot be changed.

Presets allow a quick start into the individual measurement task. Basic features such as peak and material selection and the calculation functions are already set in the presets to match the target surface.



Standard matt

Distance measurement, e.g., for ceramic material, non-transparent plastics. Highest peak, averaging, distance calculation.

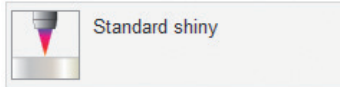

Standard shiny

Distance measurement, e.g., for metal, polished surfaces. Highest peak, Median over 5 values, distance calculation.

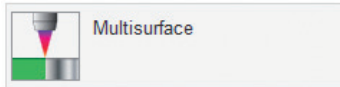

Multisurface

Distance measurement, e.g., for PCBs, hybrid materials. Highest peak, Median over 9 values, distance calculation.



One-sided thickness measurement

One-sided thickness measurement, e.g., for glass, BK7 material. First and second peak, averaging, thickness calculation

i After programming, save all settings permanently to a parameter set so that they will be available again the next time you switch on the controller. To do this, use the `Save settings` button.

1) Values apply to the `Standard` and `One-sided thickness measurement` presets.

Checking the Video Signal, Peak Selection

The video signal shows the determined reflections at the measuring object as a raw signal. The peaks are counted starting at the start of the measuring range toward the end of the measuring range. The corresponding measured value is marked by a vertical line (peak marking).

➡ Go to the **Measurement** chart menu. Display the video signal with **Video**. Adjust the settings for the exposure mode and measuring rate parameters.

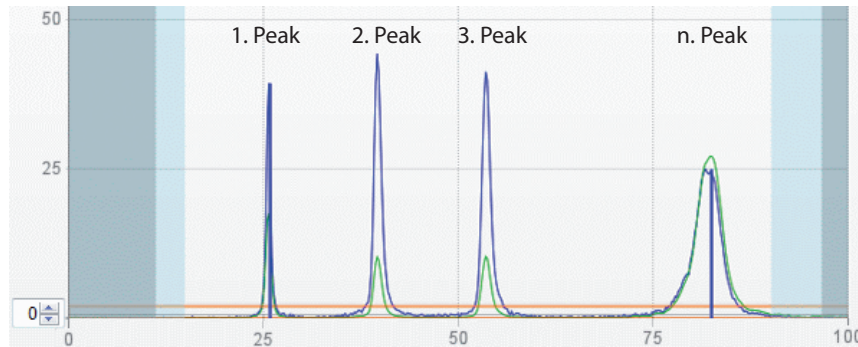

The selection of peaks dictates which region in the signal is used for the distance or thickness measurement. For a measuring object consisting of several transparent layers, use the refractive index correction to compensate for the distance measurement errors caused by optical factors, see operating instructions.

Video signal of transparent measuring object with four peaks (optical boundary areas) in the measuring range

1 measurement	first peak / highest peak / last peak
2 measurement values	first and second peak / first and last peak / second to last and last peak / highest and second highest peak

Options for peak selection

The **Standard**, **Standard shiny** and **Multisurface** presets use the highest peak.

The preset **One-sided thickness measurement** uses the 1. and 2. peak for the calculation of the measured value.

➡ Go to the **Data Recording > Settings > Peak selection** menu to select a different peak.

Distance Measurement with Website Display

➡ Align the sensor perpendicularly to the object to be measured.

➡ Then, move the sensor (or the target) closer and closer to the start of the measuring range of the relevant sensor.

As soon as the object is within the measuring field of the sensor, the controller's Range LED lights up (green or yellow). Alternatively, you can watch the video signal.

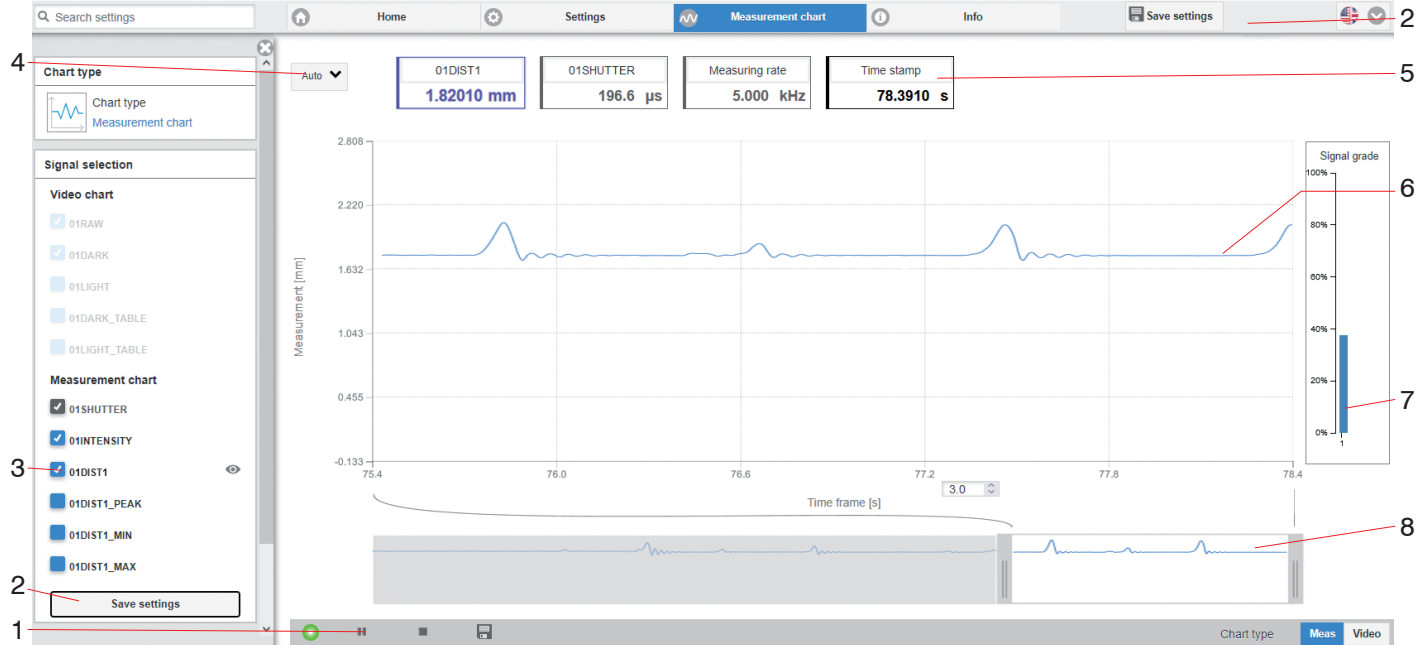

Measurement (*distance measurement*) web page

- 1 Stop pauses the chart; you can still use the data selection and zoom functions. Save opens a Windows selection dialog for the file name and storage location to save the last 10,000 values in a CSV file (separation using semicolon).
- 2 All changes only become effective when you click on the Save settings button.
- 3 In the left-hand window, the signals to be displayed can be switched on or off during or after the measurement. Inactive curves are grayed out and can be added by clicking on the check mark. The changes become effective when you save the settings.
You can show or hide the individual signals using the eye symbols . The calculation continues in the background.
 - 01SHUTTER: exposure time
 - 01xINTENSITY: Signal quality of the underlying peak in the video signal
 - 01DIST: Distance signal curve over time
- 4 To scale the axis in the graph for the measured values (y-axis), you can use Auto (= automatic scaling) or Manual (= manual scaling).
- 5 The current values for distance, exposure time, current measuring rate and time stamp are shown in the text boxes above the graph. Errors are also displayed.
- 6 Mouseover function. When the chart has been stopped and you move the mouse over the graph, points on the curve are marked with a circle and the associated values are displayed in the text boxes above the graph. The intensity bars are also updated.
- 7 The peak intensity is displayed as a bar chart.
- 8 Scaling the x-axis: During an ongoing measurement, you can use the left-hand slider to enlarge the entire signal (zoom). The time range can also be defined using an input field under the time axis. When the chart has been stopped, the right-hand slider can also be used. You can also move the zoom window with the mouse in the center of the zoom window (four-sided arrow).

One-Sided Thickness Measurement, Transparent Target

The controller evaluates two signals reflected on the surfaces. Based on these two signals, the controller calculates the distances from the surfaces and, from this, derives the thickness.

➤ Align the sensor perpendicularly to the object to be measured. Make sure that the target is approximately in the mid of the measuring range (SMR + 0.5 x MR).

i The light beam must strike the surface of the object at a perpendicular angle. Otherwise, measurements might be inaccurate.

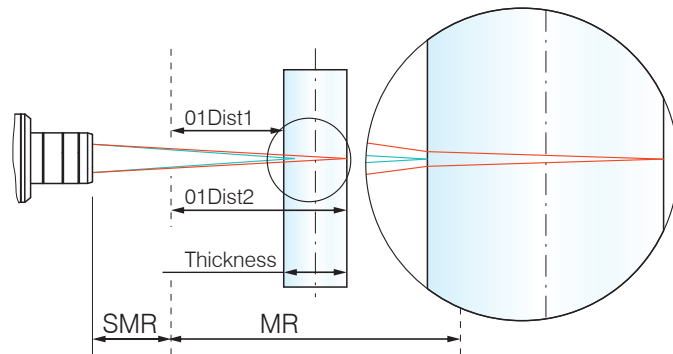

One-sided thickness measurement for a transparent target

Preset Selection

- Switch to the Home menu.
- Select One-sided thickness measurement in the Measurement configuration menu.

This presetting prompts the controller to use the first and second peak in the video signal for the thickness calculation.

Material Selection

Specifying the material is essential for calculating a correct thickness value. To compensate for the spectral change of the index of refraction, at least three refractive indices at different wavelengths or a refractive index and the Abbe number must be known.

The material table includes predefined materials.

- Switch to the Settings > Data recording > Material selection menu.
- Select the material of the target for Layer 1.

Video Signal

If a surface of the target lies outside the measuring range, the controller will send only one signal for the displacement, intensity and center of gravity. This may also occur if a signal is below the detection threshold. Two boundary surfaces are active when the correct thickness of a transparent material is measured. As a result, two peaks are visible in the video signal.



Measurement arrangement for thickness measurement:

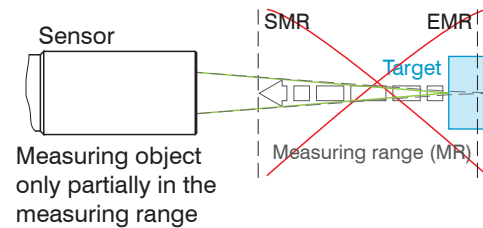
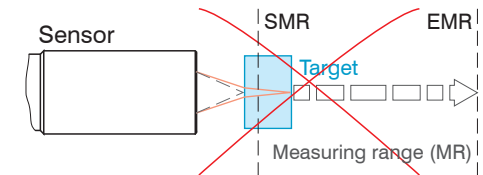
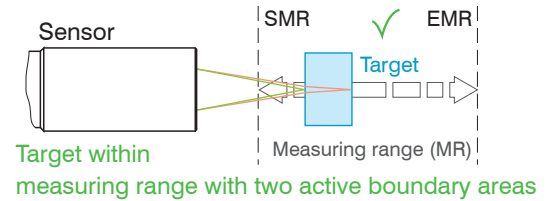

Video signal (*thickness measurement*) web page

No thickness measurement possible

Measurement Chart for Thickness Measurement

➤ Switch to the Measurement chart tab and select Meas as the chart type.

The web page shows the two distances and the thickness Ch01Thick12 (difference between 01DIST2 and 01DIST1) graphically and numerically. Optionally, the intensities of both peaks (Peak 1 = near, Peak 2 = far) can also be displayed.

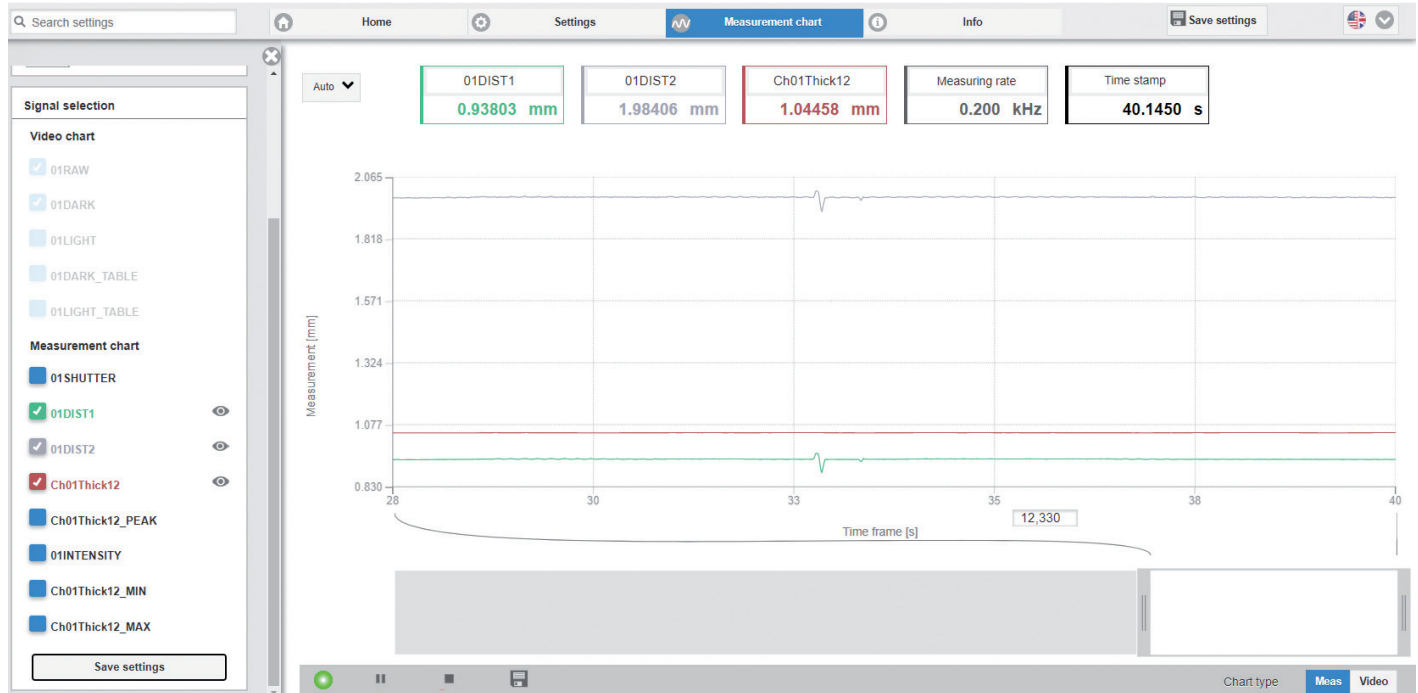

Switch between Ethernet Setup Mode and EtherCAT

The controllers start in the last stored operating mode. With the Multifunction button, you can set the controller to the EtherCAT operating mode.

► Press and hold the Multifunction button on the controller before switching on the power supply on the controller. Release the button again as soon as the Intensity LED flashes yellow. Press the button again for approx. 10 to 15 seconds until the Intensity LED flashes red.

Within the time $t_2 \dots t_3$, the red flashing with 8 Hz starts after 10 seconds. The key must be released again after 15 seconds at the latest. When the Multifunction key is released at the latest at time t_3 , the Intensity LED starts to flash yellow at 8 Hz.

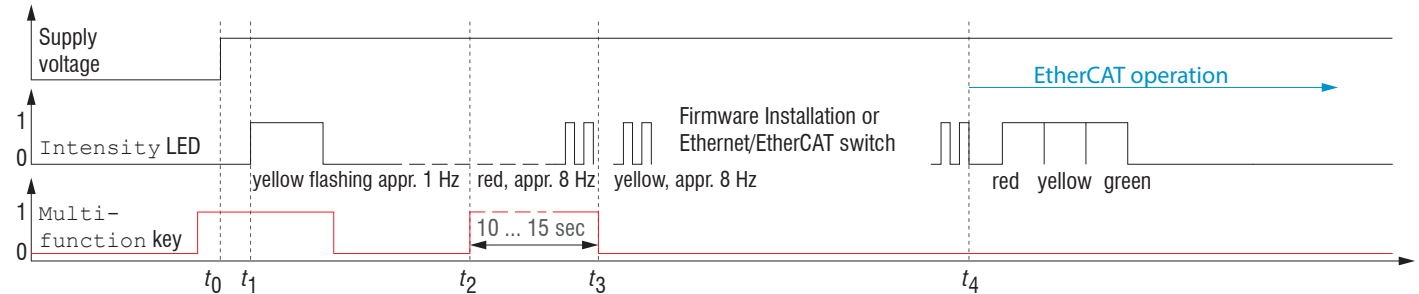

Flowchart for starting a controller in EtherCAT mode

After completion of the firmware installation/switch, the controller reboots at time t_4 .

- t_0 : Supply voltage is applied
- t_1 : The Intensity LED starts flashing yellow, the Multifunction button can be released
- t_2 : Within 15 sec. ($t_2 - t_1$), press Multifunction button again and hold for further 10 ... 15 sec. ($t_3 - t_2$)
- $t_3 \dots t_4$: Switches from Ethernet Setup Mode to EtherCAT, duration max. 1 min.
- t_4 : Controller starts in EtherCAT mode.

EtherCAT

Preliminary Remarks

The controller starts with the last stored operating mode. Default is EtherCAT. You can program the controller via SDOs. In Ethernet setup mode or with active EoE, programming is alternatively possible via Telnet or the web interface, see the sections Initial Operation, Distance Measurement and One-sided thickness measurement.

Parameter Setting via EtherCAT

The acyclic programming of the controller is done in EtherCAT via the SDOs of the CANopen protocol. For details about reading and changing SDOs, please refer to the description of your EtherCAT master.

An overview of the available SDOs can be found in the operating instructions of the controller.

Saving the Settings, Continuing EtherCAT Mode

Programming via SDOs	Programmierung über Webinterface	
	Ethernet-Setup-Mode	Ethernet over EtherCAT (EoE)
Changes to the device settings: ➡ Save the settings with SDO 0x3020:002. Changes to the measurement settings: ➡ Save the settings with SDO 0x3022:003.	- Programming via web interface ➡ Go to Settings > System settings > Load & Save or click the Save settings button. ➡ Go to Settings > System settings > Boot mode. Select the entry Industrial Ethernet (EtherCAT).	- Programming via web interface or on command level e.g. with Telnet ➡ Go to Settings > System settings > Load & Save or click the Save settings button.
➡ Activate the Run mode.	<p>The controller disconnects from the browser and boots automatically with the EtherCAT firmware. The boot process can take up to one minute.</p> <p>Alternatively, you can return to the EtherCAT mode via the Multifunction button. Details can be found in section Switch between Ethernet Setup Mode and EtherCAT.</p>	

Continue working in your PLC environment.

Service, Repair

If the sensor, controller or sensor cable is defective:

- If possible, save the current sensor settings in a parameter set to reload them into the controller after the repair.
- Please send us the affected parts for repair or exchange.

If the cause of a fault cannot be clearly identified, please send the entire measuring system to:

MICRO-EPSILON MESSTECHNIK
GmbH & Co. KG
Koenigbacher Straße 15
94496 Ortenburg / Germany
Tel. +49 (0) 8542 / 168-0
Fax +49 (0) 8542 / 168-90
info@micro-epsilon.com
www.micro-epsilon.com

Disclaimer

All components of the device have been checked and tested for functionality in the factory. However, should any defects occur despite careful quality control, these shall be reported immediately to MICRO-EPSILON or to your distributor/retailer.

MICRO-EPSILON undertakes no liability whatsoever for damage, loss or costs caused by or related in any way to the product, in particular consequential damage, e.g., due to

- non-observance of these instructions/this manual,
- improper use or improper handling (in particular due to improper installation, commissioning, operation and maintenance) of the product, repairs or modifications by third parties,
- the use of force or other handling by unqualified persons.

This limitation of liability also applies to defects resulting from normal wear and tear (e.g., to wearing parts) and in the event of non-compliance with the specified maintenance intervals (if applicable).

MICRO-EPSILON is exclusively responsible for repairs. It is not permitted to make unauthorized structural and / or technical modifications or alterations to the product. In the interest of further development, MICRO-EPSILON reserves the right to modify the design.

In addition, the General Terms of Business of MICRO-EPSILON shall apply, which can be accessed under Legal details | Micro-Epsilon <https://www.micro-epsilon.de/impressum/>.

Decommissioning, Disposal

In order to avoid the release of environmentally harmful substances and to ensure the reuse of valuable raw materials, we draw your attention to the following regulations and obligations:

- Remove all cables from the sensor and/or controller.
- Dispose of the sensor and/or controller, its components and accessories, as well as the packaging materials in compliance with the applicable country-specific waste treatment and disposal regulations of the region of use.
- You are obliged to comply with all relevant national laws and regulations

For Germany / the EU, the following (disposal) instructions apply in particular:

- Waste equipment marked with a crossed garbage can must not be disposed of with normal industrial waste (e.g. residual waste can or the yellow recycling bin) and must be disposed of separately. This avoids hazards to the environment due to incorrect disposal and ensures proper recycling of the old appliances.
- A list of national laws and contacts in the EU member states can be found at https://ec.europa.eu/environment/topics/waste-and-recycling/waste-electrical-and-electronic-equipment-weee_en. Here you can inform yourself about the respective national collection and return points.
- Old devices can also be returned for disposal to MICRO-EPSILON at the address given in the imprint at <https://www.micro-epsilon.de/impressum/>.
- We would like to point out that you are responsible for deleting the measurement-specific and personal data on the old devices to be disposed of.
- Under the registration number WEEE-Reg.-Nr. DE28605721, we are registered at the foundation Elektro-Altgeräte Register, Nordostpark 72, 90411 Nuremberg, as a manufacturer of electrical and/or electronic equipment.



MICRO-EPSILON MESSTECHNIK GmbH & Co. KG
Koenigbacher Str. 15 · 94496 Ortenburg / Germany
Tel. +49 (0) 8542 / 168-0 · Fax +49 (0) 8542 / 168-90
info@micro-epsilon.com · www.micro-epsilon.com

Your local contact: www.micro-epsilon.com/contact/worldwide/

X9691458.01-A012053MSC

© MICRO-EPSILON MESSTECHNIK