

Data Sheet for Precision Potentiometer

SIN / COS potentiometers (conductive plastic) - non-linear

Series SCX22



Sinus / Cosinus SCX22 potentiometers can be used to implement mathematical functions.

- Precise sinus cosinus potentiometer in 22 mm housing
- Very long lifespan
- 2 x ball bearings
- Electrically effective angle of rotation 360 °

This high-resolution special potentiometer in 22 mm housing makes it easy to convert movements in x-y coordinate system into adequate electrical quantities. The potentiometers are optimally used in tool manufacturing, in mechanical engineering and in meteorology. Very high precision with a very long lifespan of up to more than 50 million shaft rotations distinguish these sensors.

Electrical Data

Effective electrical angle of rotation 1.)	360° endless
Total resistance 1.)	0,5..50 kOhm
Resistance tolerance	±15% (±10%)
Independent linearity (best straight line) 1.)	±2% (±1%)
Theoretical resolution 1.)	Nearly infinite
Backlash (Hysteresis) 1.)	≤ 0,5°
Max. / recommended wiper current 1.)	10 µA / 2 µA
Power rating @ 70°C (0W @ 105°C)	0,5 W
Insulation Voltage 1.)	500 VAC, 1min
Insulation Resistance 1.)	1000 MOhm @ 500 VDC

Mechanical Data, Environmental Conditions, Miscellaneous

Mechanical angle of rotation	360° without stop
Lifetime (90% el. eff. angle half sine) 2.)	50 Mio. rotations
Max. operational speed	400 rev. / min.
Bearing	2 x ball bearing
Operational torque @ ambient temperature 1.) 2.)	3 Nmm
Operating temperature range	-55..+125°C
Storage temperature range	-55..+125°C
Protection grade (IEC 60529)	IP40
Vibration (IEC 68-2-6, Test Fc)	15g 10..2000Hz x 12h
Shock (IEC 68-2-27, Test Ea)	49g @ 11 ms x 18
Housing diameter	22,23 mm
Housing depth	22,5 mm
Shaft diameter	3 mm (optional 3,175 mm)
Shaft type	Solid shaft

Data Sheet for Precision Potentiometer

SIN / COS potentiometers (conductive plastic) - non-linear

Series SCX22

Mechanical Data, Environmental Conditions, Miscellaneous

Max. radial load	≤1 N
Max. axial load	≤1 N
Connection type	Gold plated soldering pins
Connection position	Radial
Sensor mounting	Servo flange
Mass	20 g
Fastening parts included in delivery	3 servo clamps SFN2 with screw M3 x 7,5
Material shaft	Stainless steel
Material housing	Metal

1.) According IEC 60393

2.) Determined by climatic conditions according to IEC 68-1, para. 5.3.1 without load collectives

Please note: Max. permissible supply voltage <75 VDC respectively <50 VAC in addition the max. power rating must be observed

Order code

Description	Selection: standard=black/bold, possible options=grey/cursive						
Series	SCX22						
Resistance value / Option Tandem:			<i>Tandem*</i>				
Option 500 Ohm		<i>R500</i>	<i>/500</i>				
1 kOhm		R1k	/1k				
Option 2 kOhm		<i>R2k</i>	<i>/2k</i>				
5 kOhm		R5k	/5k				
10 kOhm		R10k	/10k				
Option 20 kOhm		<i>R20k</i>	<i>/20k</i>				
Option 50 kOhm		<i>R50k</i>	<i>/50k</i>				
Option rear shaft: Standard Ø3,00 x 10 mm Shaft length in mm Shaft diameter in mm (≤3,00 mm)				<i>RA</i> <i>RAxx,xx</i> <i>RADMx,xx</i>			
Resistance tolerance: ±15% Option ±10%					W15% <i>W10%</i>		
Independent linearity: ±2% Option ±1%						L2% <i>L1%</i>	
Option front shaft: Standard Ø3,00 x 11,5 mm Option Ø3,175 mm Option shaft length in mm Option shaft diameter in mm (≤3 mm)							- <i>DM3,175</i> <i>Ax,xx</i> <i>DMx,xx</i>
Option screwdriver slot:							<i>B</i>

*Housing length +16 mm

For higher quantities or on-going demand, additional options are available as described below on request

For Example: Multi ganged potentiometers (max. 3) / housing length +16 mm per gang, oil-filled version, special electrical and mechanical angles of rotation, and special resistance and linearity tolerances. Furthermore we can mount gear wheels or attach cable assemblies with or without connectors and much more.

Data Sheet for Precision Potentiometer

SIN / COS potentiometers (conductive plastic) - non-linear

Series SCX22

Drawing

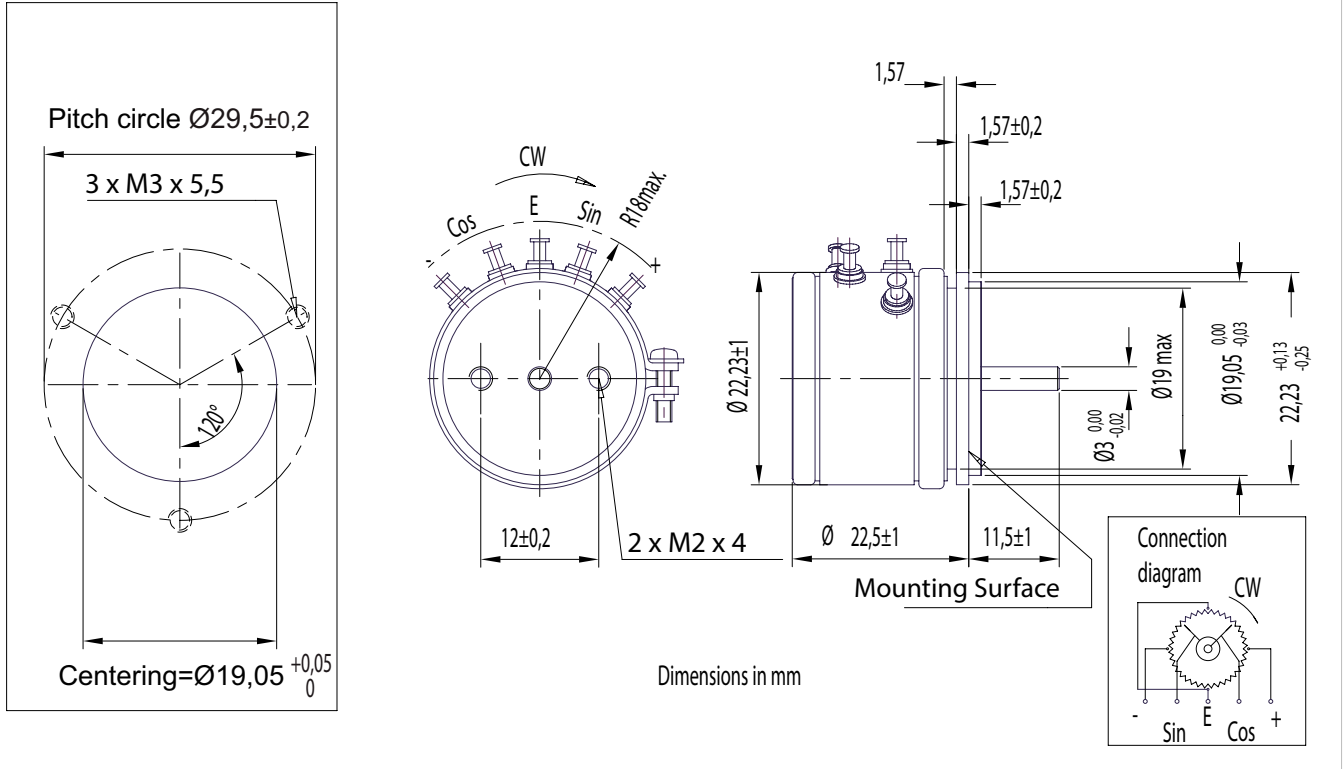

Data Sheet for Precision Potentiometer



SIN / COS potentiometers (conductive plastic) - non-linear

Series SCX22

On Request: Special machining on shaft

Slot

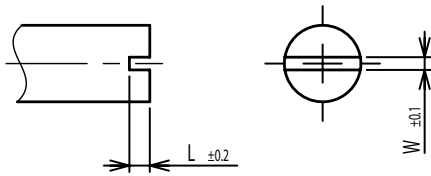

Groove

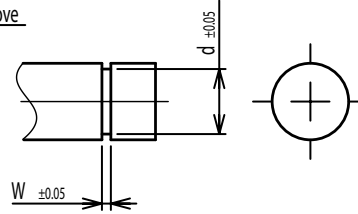

Flat

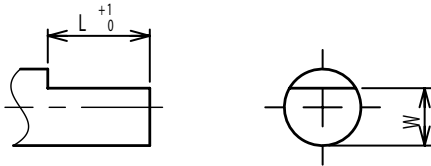

Round top

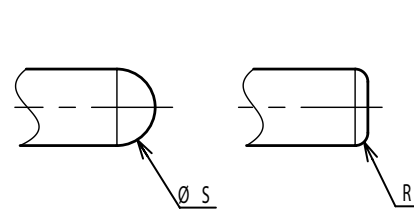

Double side flat

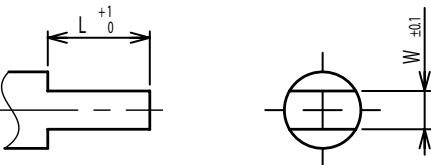

Counterbore hole

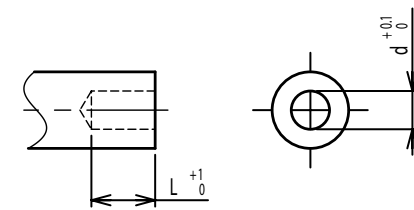

Step

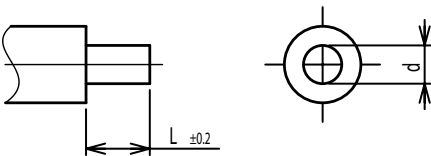

Counterbore screw hole

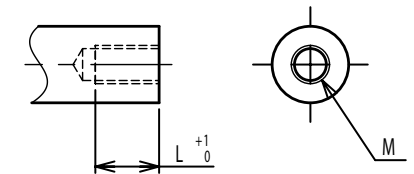

Screw Thread

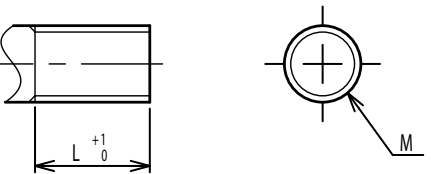

Pin hole

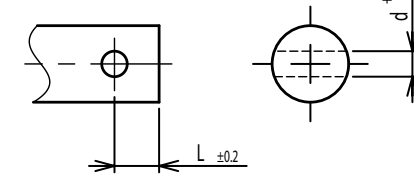

Knurled(Parallel)

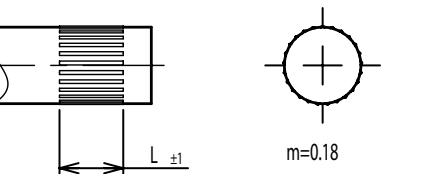

Screw thread inside hole

