

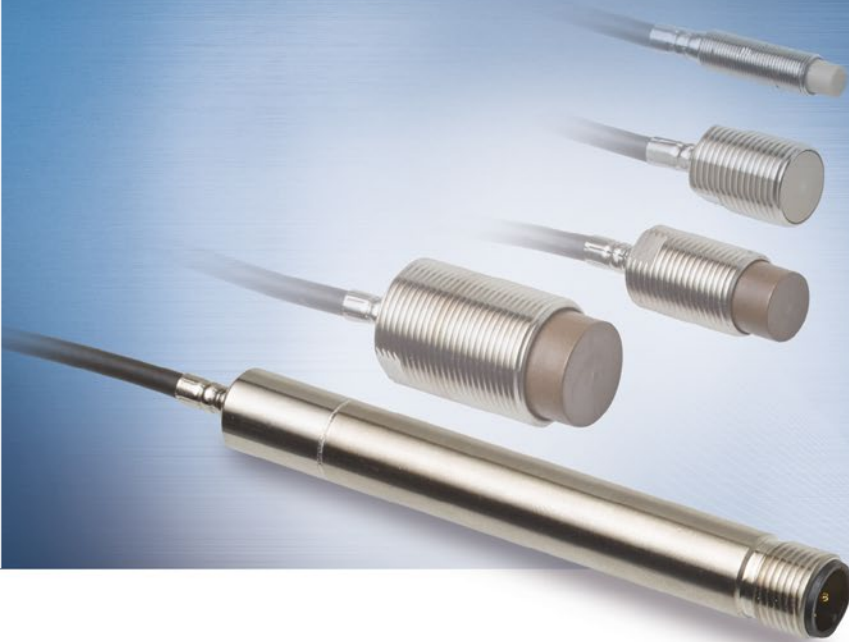







More Precision

eddyNCDT // Inductive sensors based on eddy currents





	Compact and robust design
	Temperature compensation up to 180 °C
	High measurement accuracy
	Frequency response 5 kHz (-3dB)
	For ferromagnetic and non-ferro-magnetic materials
	Robust design IP67

Robust eddy current measuring system

The eddyNCDT 3005 is a powerful eddy current measuring system for fast, high precision displacement measurements. The system comprises a compact controller, a sensor and an integrated cable and is factory-calibrated for ferromagnetic or non-ferromagnetic materials.

As sensor and controller are temperature-compensated, high measurement accuracies can be achieved even in fluctuating temperatures. The sensors are designed for ambient temperatures up to max. +125 °C but can optionally be custom engineered for temperatures from -30 °C to 180 °C. The measuring system is pressure-resistant up to 10 bar and so is ideally suited to machine integration.

Integration into plant and machinery

The eddyNCDT 3005 provides ease of use and high measurement accuracy, offering an outstanding price/performance ratio. Therefore, the sensor is ideal for OEM integration and serial applications in machine building, particularly where pressure, dirt, oil and high temperatures are present. When large quantities are required, customer-specific designs can be tailored to suit individual requirements.



Its compact M12 design allows for the controller to be easily installed in restricted and difficult-to-access places.

Pin assignment for power supply and signal

Pin	Assignment	Color (cable: PCx/5-M12)
1	Supply +24 V	Brown
2	Displacement signal	White
3	GND	Blue
4	internal	Black
5	internal	Gray



5-pin housing connector M12x1
View on pin side

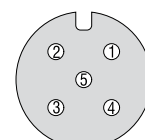

Model	DT3005-U1-A-C1	DT3005-U1-M-C1	DT3005-S2-A-C1	DT3005-S2-M-C1	DT3005-U3-A-C1	DT3005-U3-M-C1	DT3005-U6-A-C1	DT3005-U6-M-C1
Measuring range	1 mm		2 mm		3 mm		6 mm	
Start of measuring range	0.1 mm		0.2 mm		0.3 mm		0.6 mm	
Resolution ¹⁾	0.5 μm		1 μm		1.5 μm		3 μm	
Frequency response (-3dB)	5 kHz							
Linearity	< ±2.5 μm		< ±5 μm		< ±7.5 μm		< ±15 μm	
Repeatability	< 0.5 μm		< 1 μm		< 1.5 μm		< 3 μm	
Temperature stability	< 0.25 μm / K		< 0.5 μm / K		< 0.75 μm / K		< 1.5 μm / K	
Temperature compensation	Sensor		+10 ... +125 °C (optional -30 ... +180 °C)					
	Controller		+10 ... +60 °C					
Sensor type	unshielded		shielded		unshielded		unshielded	
Min. target size (flat)	ø 24 mm		ø 24 mm		ø 48 mm		ø 72 mm	
Target material ²⁾	Aluminum	Steel	Aluminum	Steel	Aluminum	Steel	Aluminum	Steel
Supply voltage	12 ... 32 VDC							
Analog output	0.5 ... 9.5V							
Synchronization	with LF & HF variants (please consider the notes for frequency separation, p. 46)							
Connection	Sensor: integrated cable, length 1 m, min. bending radius 18 mm Supply/signal: 5-pole M12 connector (cable see accessories)							
Temperature range	Storage		-20 ... +80 °C					
	Operation		Sensor: -20 ... +125 °C (optional -20 ... +180 °C), Controller: 0 ... +70 °C					
Pressure resistance	10 bar (sensor, cable and controller)							
Shock (DIN EN 60068-2-27)	15 g / 6 ms in 3 axes, 2 directions and 1000 shocks each							
Vibration (DIN EN 60068-2-6)	5 g / 10 ... 500 Hz in 3 axes, 2 directions and 10 cycles each							
Protection class (DIN EN 60529)	IP67							
Weight ³⁾	70 g		75 g		77 g		95 g	

¹⁾ RMS noise relates to mid of measuring range at a frequency response of 5 kHz
²⁾ Steel: St37 steel DIN1.0037 / aluminum: AlCuMgPb3.1645 / AlMg3
³⁾ Total weight for controller, cable and sensor

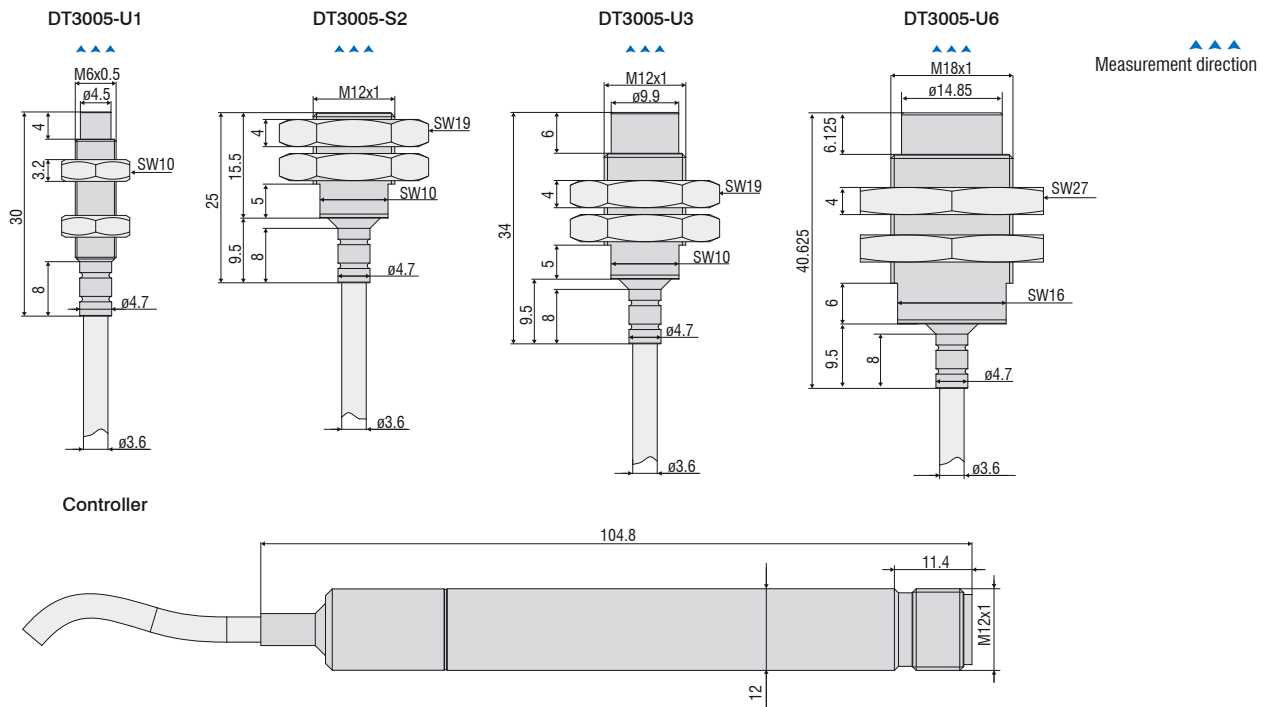

Dimensions in mm, not to scale.

Article	Description	DT3001	DT3005	DT3060	DT3070	DT3300	DZ140	SGS
PCx/8-M12	Supply and signal cable 8-pole with M12 connector Standard length: 3 m Optionally available: 5 m / 10 m / 15 m / 10 m as drag-chain suitable variant			X	X			
PCx/5-M12	Supply and signal cable 5-pole with M12 connector Standard length: 5 m Optionally available: 20 m	X	X					
PC4701-x	Supply and signal cable 8-pole with M12 connector Standard length: 10 m Optionally available: 15 m / 10 m as drag-chain suitable variant							X
SCD2/4/RJ45	Industrial Ethernet cable 4-pole with M12 connector on RJ45 connector Standard length: 2 m			X	X			
SCAx/5	Signal cable, analog 5-pole with M16x0.75 connector Standard length: 3 m Optionally available: 6 m / 9 m					X		
SCDx/8	Signal cable for switching inputs and outputs: 8-pole with M16x0.75 connector Standard length: 0.3 m Optionally available: 1 m					X		
PSCx	Supply and synchronization cable 5-pole with M9 connector Standard length: 0.3 m Optionally available: 1 m					X		
ESCx	Synchronization cable 5-pole with M9 connector Standard length: 0.3 m Optionally available: 1 m					X		
PC140-x	Supply and signal cable 8-pole connector Standard length: 3 m Optionally available: 6 m						X	
PS2020	Power supply unit Input 100-240 VAC output 24 VDC / 2.5 A; mounting onto symmetrical standard rail 35 mm x 7.5 mm, DIN 50022	X	X	X	X	X	X	X

Sensors and Systems from Micro-Epsilon



Sensors and systems for displacement, distance and position



Sensors and measurement devices for non-contact temperature measurement



Measuring and inspection systems for metal strips, plastics and rubber



Optical micrometers and fiber optics, measuring and test amplifiers



Color recognition sensors, LED analyzers and inline color spectrometers

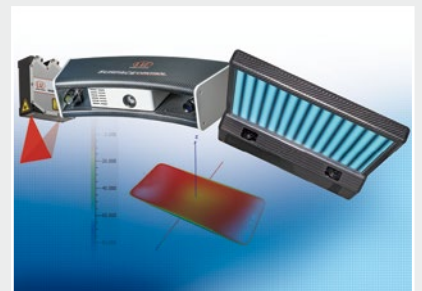

3D measurement technology for dimensional testing and surface inspection