



More Precision

eddyNCDT // Inductive sensors based on eddy currents





	Compact M12 sensor design with integrated controller
	Frequency response 5 kHz (-3dB)
	Sensors for ferromagnetic and non-ferromagnetic targets
	Temperature compensation up to 70 °C
	Easy to use (plug & play)
	Robust design to IP67

Robust M12 miniature eddy current sensor

The two eddyNCDT 3001 U2 and U4 models are powerful eddy current sensors whose compact dimensions have to date only been reserved for inductive sensors and proximity sensors. These compact sensors come with integrated controller including temperature compensation while offering an excellent price/performance ratio, as well as easy operation. Therefore, the sensors are ideally suited to OEM integration and machine building applications.

The temperature-compensated design provides high stability even in fluctuating ambient temperatures. The sensors are factory-calibrated for ferromagnetic and non-ferromagnetic materials, which eliminates the need for on-site linearization of the sensor. Its robust design combined with the eddy current measuring principle enables measurements in harsh industrial environments (oil, pressure, dirt). In addition, the eddyNCDT 3001 is suitable for offshore/marine applications (salt water).

Model	DT3001-U2-A-SA	DT3001-U2-M-SA	DT3001-U4-A-SA	DT3001-U4-M-SA	DT3001-U4-A-Cx	DT3001-U4-M-Cx
Measuring range	2 mm		4 mm			
Start of measuring range			0.4 mm			
Resolution ¹⁾			4 μ m			
Frequency response (-3dB)			5 kHz			
Linearity			< $\pm 28 \mu$ m			
Temperature stability	< 0.6 μ m / K		< 1.2 μ m / K			
Temperature compensation			0 ... +70 °C			
Sensor type			unshielded			
Min. target size (flat)			\varnothing 48 mm			
Target material ²⁾	Aluminum	Steel	Aluminum	Steel	Aluminum	Steel
Supply voltage	12 ... 32 VDC					
Analog output	0.5 ... 9.5V				0.5 ... 4.5V	
Synchronization	with LF & HF variants (please consider the notes for frequency separation, p. 46)					
Connection	Supply/signal: 5-pole M12 connector (cable see accessories)				integrated cable, 5-pin, lengths: 3/6/9 m	
Temperature range	Storage	-20 ... +80 °C				
	Operation	0 ... +70 °C				
Shock (DIN EN 60068-2-27)	15 g / 6 ms in 3 axes, 2 directions and 1000 shocks each					
Vibration (DIN EN 60068-2-6)	5 g / 10 ... 500 Hz in 3 axes, 2 directions and 10 cycles each					
Protection class (DIN EN 60529)	IP67 (plugged)				IP67	
Weight	25 g				60 g (3 m) 100 g (6 m) 140 g (9 m)	

¹⁾ RMS noise relates to mid of measuring range at a frequency response of 5 kHz

²⁾ Steel: St37 steel DIN1.0037 / aluminum: AlCuMgPb3.1645 / AlMg3

DT3001-U2-SA DT3001-U4-SA

DT3001-U2-Cx DT3001-U4-Cx

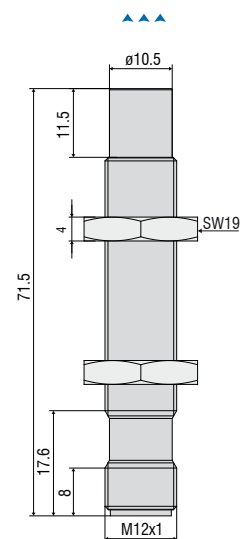

Pin assignment for power supply and signal

Pin	Assignment	Color (cable: PCx/5-M12)
1	Supply +24 V	Brown
2	Displacement signal	White
3	GND	Blue
4	internal	Black
5	internal	Gray

 5-pin housing connector M12x1
View on pin side

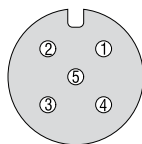

Measurement direction
Connector side

Dimensions in mm, not to scale.

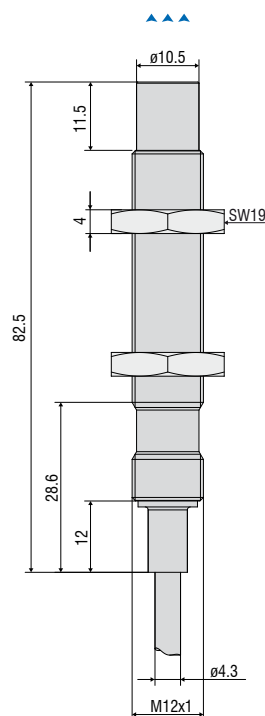

Pin assignment of integrated supply and signal cable

Assignment	Cable color
Supply +24 V	Brown
Displacement signal	Green
GND	White
internal	Yellow
internal	Gray



	Compact M18 sensor design with integrated controller
	Frequency response 5 kHz (-3dB)
	Sensors for ferromagnetic and non-ferromagnetic targets
	Temperature compensation up to 70 °C
	Easy to use (plug & play)
	Robust design to IP67

Robust miniature sensors in M18 housing

The U6 and U8 models of the eddyNCDT 3001 series are powerful eddy current sensors with integrated controller in an M18 design. Calibrated for ferromagnetic or non-ferromagnetic materials, these compact sensors offer measuring ranges of 6 mm or 8 mm.

As these sensors are temperature-compensated, they provide high signal stability even in fluctuating ambient temperatures. Due to their robust design, these sensors are used for measurement tasks in harsh, industrial environments.

Model	DT3001-U6-A-SA	DT3001-U6-M-SA	DT3001-U8-A-SA	DT3001-U8-M-SA
Measuring range	6 mm		8 mm	
Start of measuring range	0.6 mm		0.8 mm	
Resolution ¹⁾	3 μ m		4 μ m	
Frequency response (-3dB)	5 kHz			
Linearity	< $\pm 15 \mu$ m		< $\pm 20 \mu$ m	
Temperature stability	< 1.5 μ m / K		< 2 μ m / K	
Temperature compensation	0 ... +70 °C			
Sensor type	unshielded			
Min. target size (flat)	\varnothing 72 mm			
Target material ²⁾	Aluminum	Steel	Aluminum	Steel
Supply voltage	12 ... 32 VDC			
Analog output	0.5 ... 9.5 V			
Digital output	RS485			
Synchronization	with LF & HF variants (please consider the notes for frequency separation, p. 46)			
Connection	Supply/signal: 5-pole M12 connector (cable see accessories)			
Temperature range	Storage	-20 ... +70 °C		
	Operation	-20 ... +70 °C		
Shock (DIN EN 60068-2-27)	15 g / 6 ms in 3 axes, 2 directions and 1000 shocks each			
Vibration (DIN EN 60068-2-6)	5 g / 10 ... 500 Hz in 3 axes, 2 directions and 10 cycles each			
Protection class (DIN EN 60529)	IP67 (plugged)			
Weight	35 g (without nuts)			

¹⁾ RMS noise relates to mid of measuring range at a frequency response of 5 kHz

²⁾ Steel: St37 steel DIN 1.0037 / aluminum: AlCuMgPb3.1645 / AlMg3

DT3001-U6-SA

DT3001-U8-SA

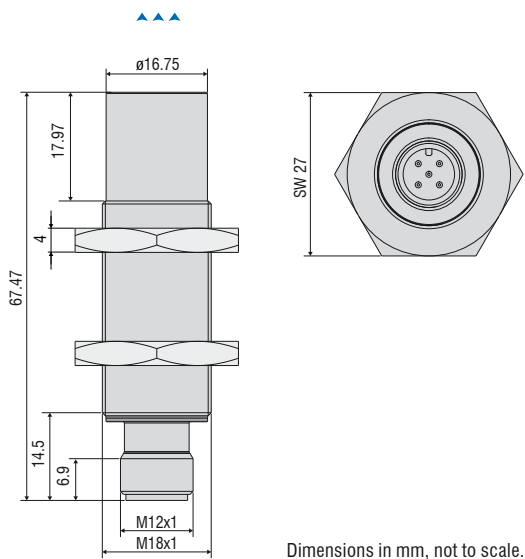

Pin assignment for power supply and signal

Pin	Assignment	Color (cable: PCx/5-M12)
1	Supply +24 V	Brown
2	Analog output	White
3	GND	Blue
4	RS485 (A+)	Black
5	RS485 (B-)	Gray



5-pin housing connector M12x1
View on pin side

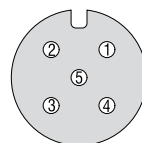

Article	Description	DT3001	DT3005	DT3060	DT3070	DT3300	DZ140	SGS
PCx/8-M12	Supply and signal cable 8-pole with M12 connector Standard length: 3 m Optionally available: 5 m / 10 m / 15 m / 10 m as drag-chain suitable variant			X	X			
PCx/5-M12	Supply and signal cable 5-pole with M12 connector Standard length: 5 m Optionally available: 20 m	X	X					
PC4701-x	Supply and signal cable 8-pole with M12 connector Standard length: 10 m Optionally available: 15 m / 10 m as drag-chain suitable variant							X
SCD2/4/RJ45	Industrial Ethernet cable 4-pole with M12 connector on RJ45 connector Standard length: 2 m			X	X			
SCAx/5	Signal cable, analog 5-pole with M16x0.75 connector Standard length: 3 m Optionally available: 6 m / 9 m					X		
SCDx/8	Signal cable for switching inputs and outputs: 8-pole with M16x0.75 connector Standard length: 0.3 m Optionally available: 1 m					X		
PSCx	Supply and synchronization cable 5-pole with M9 connector Standard length: 0.3 m Optionally available: 1 m					X		
ESCx	Synchronization cable 5-pole with M9 connector Standard length: 0.3 m Optionally available: 1 m					X		
PC140-x	Supply and signal cable 8-pole connector Standard length: 3 m Optionally available: 6 m						X	
PS2020	Power supply unit Input 100-240 VAC output 24 VDC / 2.5 A; mounting onto symmetrical standard rail 35 mm x 7.5 mm, DIN 50022	X	X	X	X	X	X	X

Sensors and Systems from Micro-Epsilon

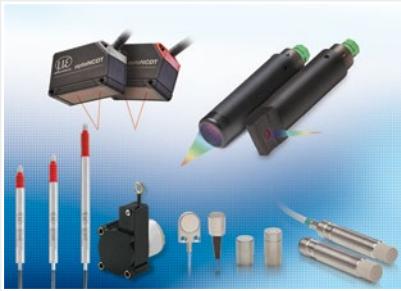

Sensors and systems for displacement, distance and position



Sensors and measurement devices for non-contact temperature measurement



Measuring and inspection systems for metal strips, plastics and rubber



Optical micrometers and fiber optics, measuring and test amplifiers



Color recognition sensors, LED analyzers and inline color spectrometers

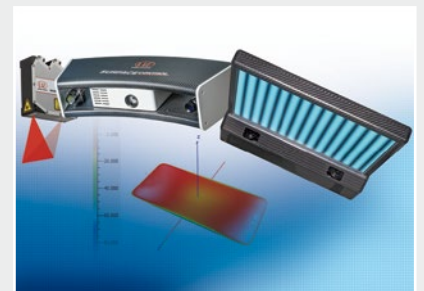

3D measurement technology for dimensional testing and surface inspection