











More Precision.

confocalDT // Confocal chromatic sensor system



Light-intensive controller for high speed measurements

confocalDT IFC246x

-  Measuring rate up to 30 kHz
-  Ethernet / EtherCAT / RS422 / PROFINET / Ethernet/IP / Analog
-  Fast surface compensation and high light intensity
-  Configuration via web interface
-  Submicron resolution
-  Thickness measurement of multi-layer materials
-  Synchronous two-sided thickness measurement
-  Robust design with passive cooling



The confocalDT 2465 and 2466 controllers enable fast, high-precision distance and thickness measurements up to 30 kHz. They are available as a single- or dual-channel variant. In addition, the MP models measure the thickness of up to 5 transparent layers at once. The controllers are characterized by high luminous intensity which enables very fast and reliable measurements even on dark surfaces.

The controller can be operated with any IFS sensor and is available as a standard version for distance measurements or as a multi-peak version for multi-layer thickness measurements. Using a special calculation function, the confocalDT 2466 dual-channel version evaluates both channels. Measurement acquisition is synchronous and can be carried out while exploiting the full measuring rate for both channels.

Due to a user-friendly web interface, no additional software is necessary to configure the controller and the sensors. Data output is via Ethernet, EtherCAT, RS422 or analog output. Optionally available interface modules enable the data to be output also via PROFINET or EtherNet/IP.



Settings are made via the web interface. For thickness measurements, materials are stored in an expandable materials database.

Model	IFC2465	IFC2465MP	IFC2466	IFC2466MP
Resolution	Ethernet/EtherCAT	1 nm		
	RS422	18 bit		
	Analog	16 bits (teachable)		
Measuring rate	continuously adjustable from 100 Hz to 30 kHz			
Linearity	typ. < $\pm 0.025\%$ FSO (depends on sensor)			
Multi-layer measurement	1 layer	5 layers	1 layer	5 layers
Light source	internal white LED			
No. of characteristic curves	up to 20 characteristic curves for different sensors per channel, selection via table in the menu			
Permissible ambient light ¹⁾	30,000 lx			
Synchronization	yes			
Supply voltage	24 VDC $\pm 15\%$			
Power consumption	approx. 10 W			
Signal input	sync-in / trig-in; 2x encoders (A+, A-, B+, B-, index)			
Digital interface	Ethernet / EtherCAT / RS422 / PROFINET ²⁾ / EtherNet/IP ²⁾			
Analog output	Current: 4 ... 20 mA; voltage: 0 ... 10 V (16 bit D/A converter)			
Switching output	Error1-Out, Error2-Out			
Digital output	sync-out			
Connector	Optical	pluggable optical fiber via E2000 socket, length 2 m ... 50 m, min. bending radius 30 mm		
	Electrical	3-pin supply terminal strip; encoder connection (15-pin, HD-sub socket, max. cable length 3 m, 30 m with external encoder supply); RS422 connection socket (9-pin, Sub-D, max. cable length 30 m); 3-pin output terminal strip (max. cable length 30 m); 11-pin I/O terminal strip (max. cable length 30 m); RJ45 socket for Ethernet (out) / EtherCAT (in/out) (max. cable length 100 m)		
Mounting	free-standing, DIN rail mounting			
Temperature range	Storage	-20 ... +70 °C		
	Operation	+5 ... +50 °C		
Shock (DIN EN 60068-2-27)	15 g / 6 ms in XYZ axis, 1000 shocks each			
Vibration (DIN EN 60068-2-6)	2 g / 20 ... 500 Hz in XYZ axis, 10 cycles each			
Protection class (DIN EN 60529)	IP40			
Material	Aluminum			
Weight	approx. 1.8 kg		approx. 2.25 kg	
Compatibility	compatible with all confocalDT sensors			
No. of measurement channels ³⁾	1		2	
Control and indicator elements	Multifunction button (two adjustable functions and reset to factory setting after 10 s); 5x LEDs for intensity, range, status and supply voltage			

FSO = Full Scale Output

¹⁾ Illuminant: light bulb

²⁾ Connection via interface module (see accessories)

³⁾ No loss of intensity and linearity due to two synchronous measurement channels

IFC2465 Controller

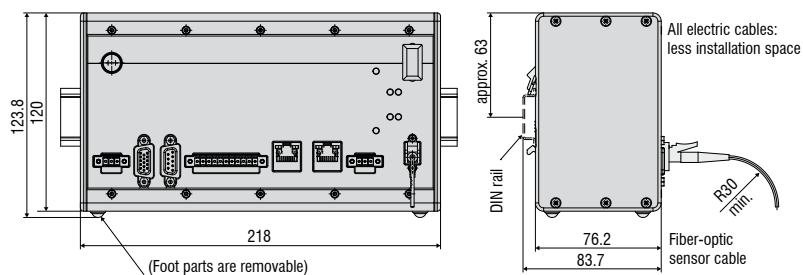

IFC2466 Controller

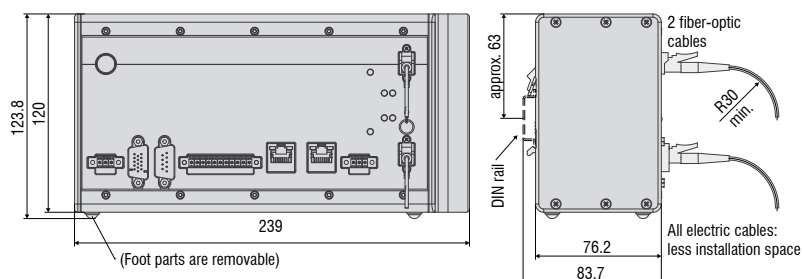

System design

confocalDT

The confocalDT system consists of:

- Sensor IFS240x
- Controller IFC24xx
- Fiber optic cable C24xx

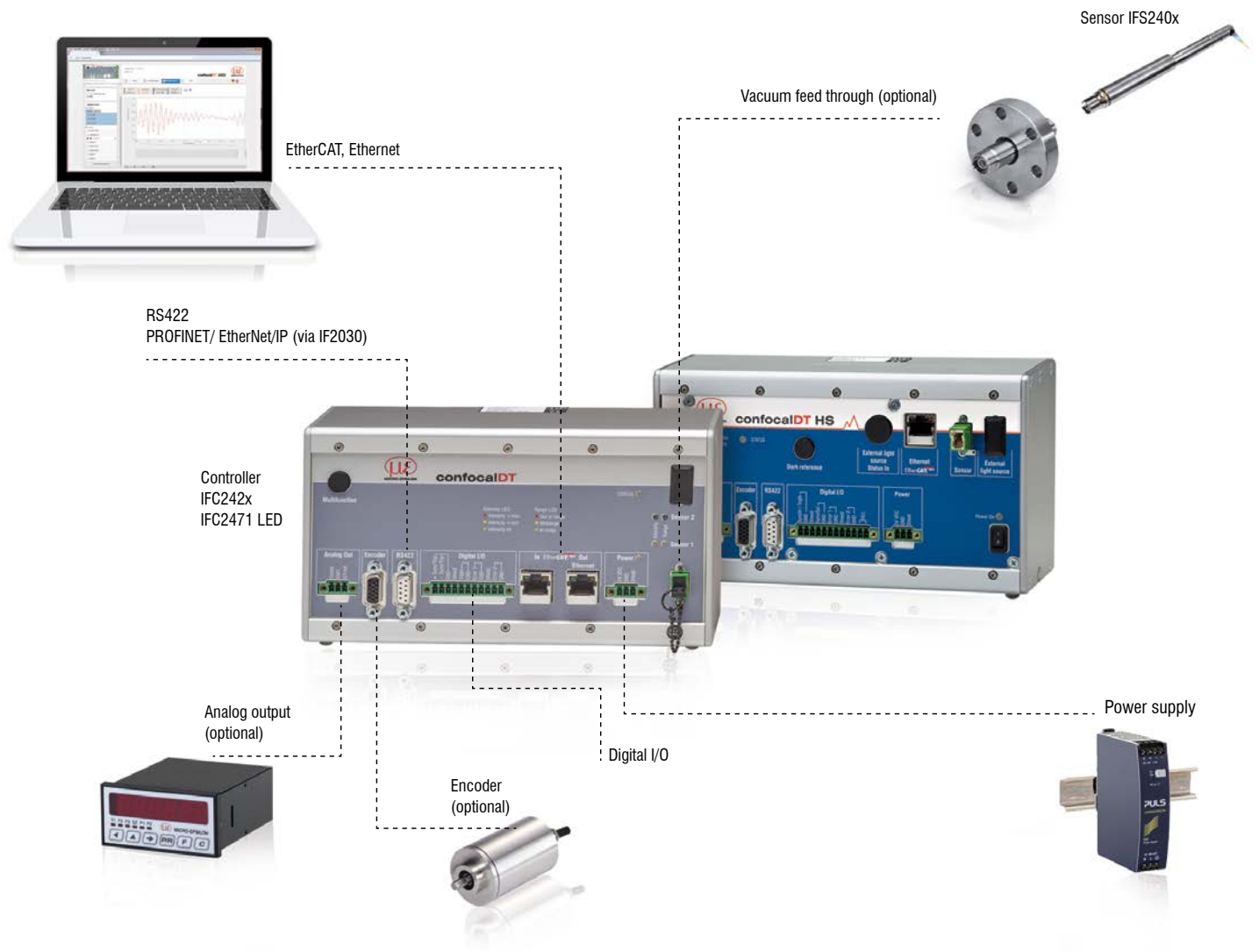

Customer-specific modifications

Application examples are often found where the standard versions of the sensors and the controllers are performing at their limits. To facilitate such special tasks, it is possible to customize the sensor design and to adjust the controller accordingly. Common requests for modifications include changes in design, mounting options, customized cable lengths and modified measuring ranges.



Possible modifications

- Sensors with connector
- Cable length
- Vacuum suitability up to UHV
- Specific lengths
- Customer-specific mounting options
- Optical filter for ambient light compensation
- Housing material
- Measuring range / Offset distance

Vacuum setup

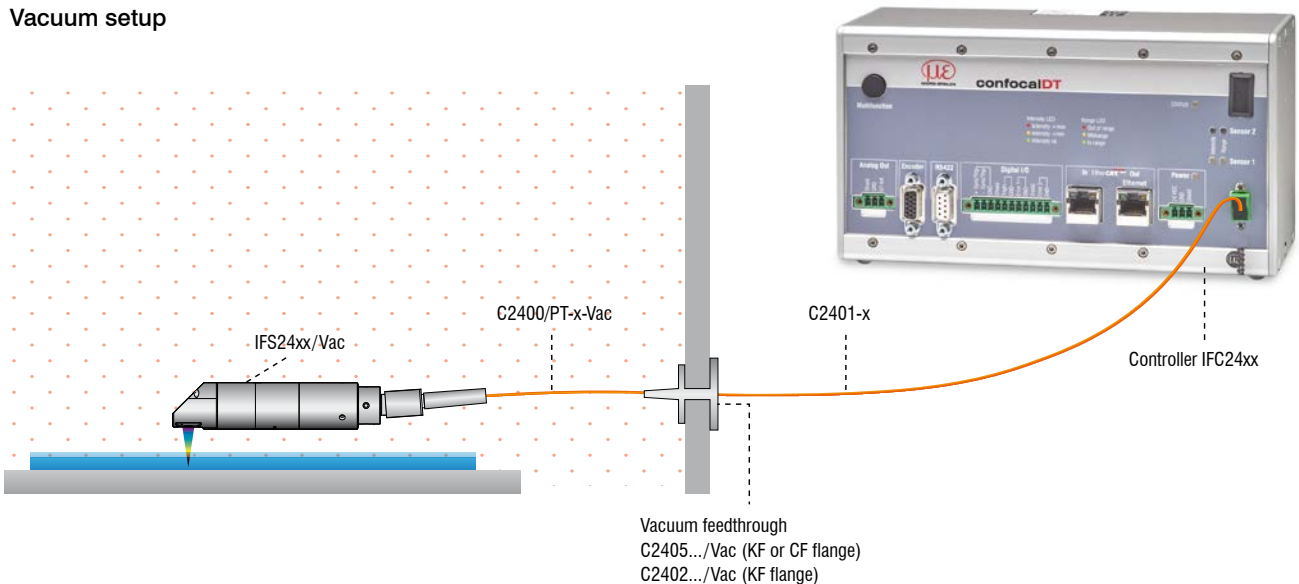

Accessories: mounting adapter
MA2402 for sensors 2402

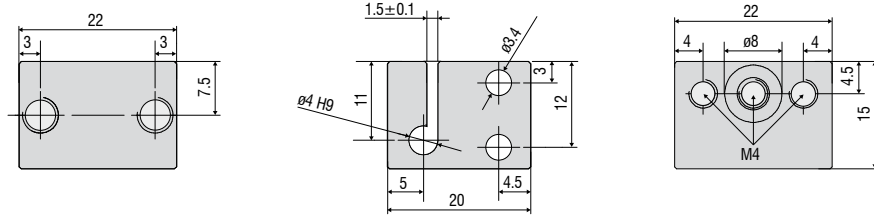

Accessories: mounting adapter
MA2403 for sensors 2403

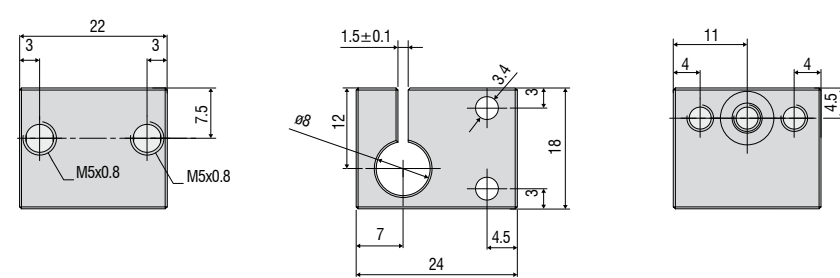

Accessories: mounting adapter
MA2404-12 for sensors IFS2404-2 / IFS2404/90-2 / IFS2407-0,1

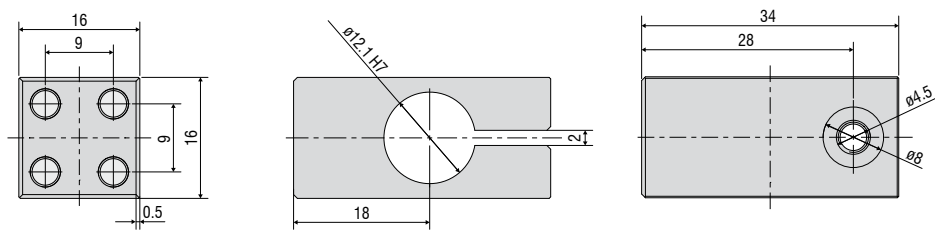

Accessories: mounting adapter
MA2400 for sensors IFS2405 / IFS2406 / IFS2407 (consisting of a mounting block and a mounting ring)

Mounting block

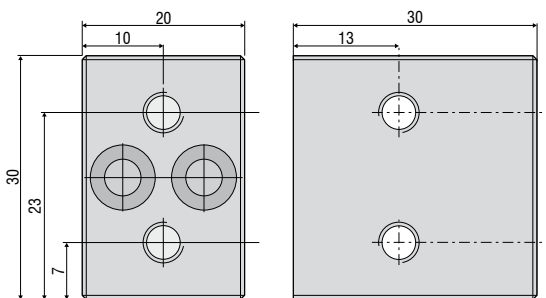

Mounting ring

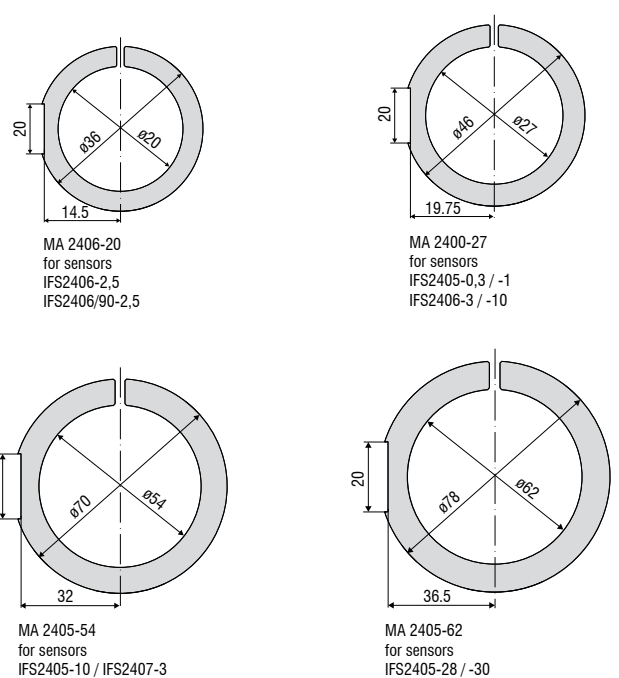

Adjustable mounting adapter

The adjustable JMA mounting adapter simplifies the alignment and fine adjustment of confocal sensors. You can integrate the sensors with the adapter directly into the machine and then align them directly on site. This corrects, e.g. minor deviations caused by mounting and compensates for tilted measuring objects. With two-sided thickness measurements, the mounting adapter supports the fine alignment of the two measuring points.

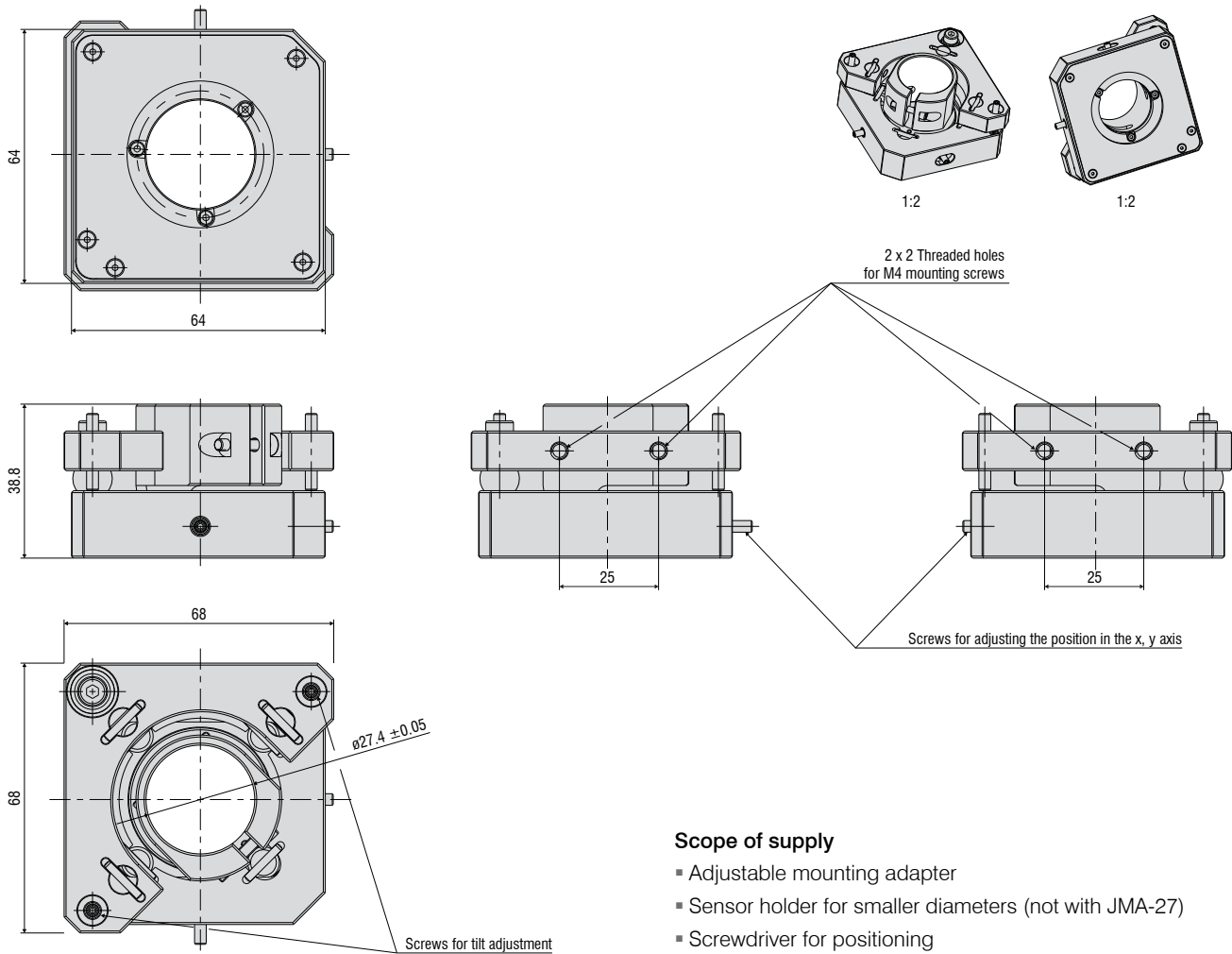

Scope of supply

- Adjustable mounting adapter
- Sensor holder for smaller diameters (not with JMA-27)
- Screwdriver for positioning
- Assembly instructions

Sensor holder for smaller diameters

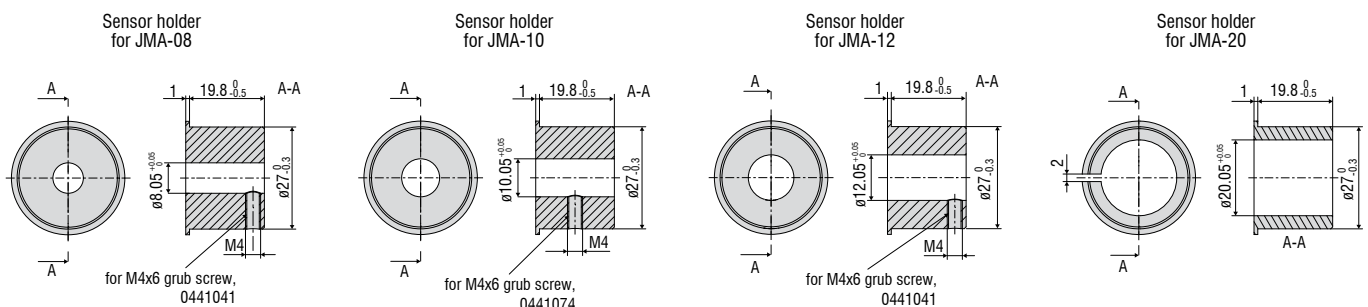

Software

IFD24xx-Tool Software demo tool included

Accessories light source

IFL2422/LED Lamp module for IFC2422 and IFC2466
IFL24x1/LED Lamp module for IFC2421, IFC2465 and IFC2471

Cable extension for sensors

CE2402 cable with 2x E2000/APC connectors
CE2402-x Extension for optical fiber (3 m, 10 m, 13 m, 30 m, 50 m)
CE2402/PT3-x Extension for optical fiber with protection tube for mechanical stress
(3 m, 10 m, customer-specific length up to 50 m)

Cable for IFS2404 sensors

C2404-x Optical fiber with FC/APC and E2000/APC connectors
Fiber core diameter 20 μm (2 m)

Cables for IFS2405/IFS2406/2407-0,1 sensors

C2401 cable with FC/APC and E2000/APC connectors
C2401-x Optical fiber (3 m, 5 m, 10 m, customer-specific length up to 50 m)
C2401/PT3-x Optical fiber with protection tube for mechanical stress
(3 m, 5 m, 10 m, customer-specific length up to 50 m)
C2401-x(01) Optical fiber core diameter 26 μm (3 m, 5 m, 15 m)
C2401-x(10) Drag-chain suitable optical fiber (3 m, 5 m, 10 m)

C2400 cable with 2x FC/APC connectors

C2400-x Optical fiber (3 m, 5 m, 10 m, customer-specific length up to 50 m)
C2400/PT-x Optical fiber with protection tube for mechanical stress
(3 m, 5 m, 10 m, customer-specific length up to 50 m)
C2400/PT-x-Vac Optical fiber with protection tube suitable for use in vacuum
(3 m, 5 m, 10 m, customer-specific length up to 50 m)

Cable for IFS2407/90-0,3 sensors

C2407-x Optical fiber with DIN connector and E2000/APC (2 m, 5 m)

Vacuum feedthrough

- C2402/Vac/KF16 Vacuum feed through with optical fiber, 1 channel, vacuum side FC/APC non-vacuum side E2000/APC, clamping flange KF 16
- C2405/Vac/1/KF16 Vacuum feed through on both sides FC/APC socket, 1 channel, clamping flange type KF 16
- C2405/Vac/1/CF16 Vacuum feed through on both sides FC/APC socket, 1 channel, flange type CF 16
- C2405/Vac/6/CF63 Vacuum feed through FC/APC socket, 6 channels, flange type CF 63

Other accessories

- SC2471-x/USB/IND Connector cable IFC2461/71, 3 m, 10 m, 20 m
- SC2471-x/IF2008 Connector cable IFC2461/71-IF2008, 3 m, 10 m, 20 m
- PS2020 Power supply 24 V / 2.5 A
- EC2471-3/OE Encoder cable, 3 m
- IF2030/PNET Interface module for PROFINET connection
- IF2030/ENETIP Interface module for EtherNet/IP connection

Optical fiber

Temperature range: -50 °C to 90 °C
 Bending radius: 30/40 mm

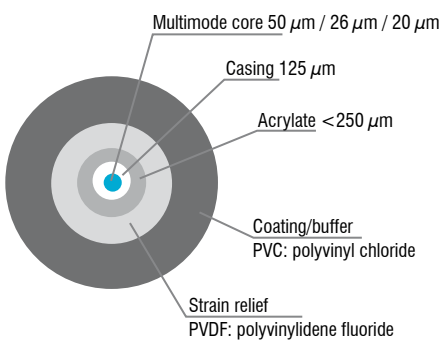

E2000/APC Standard connector

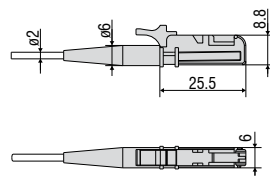

FC/APC Standard connector

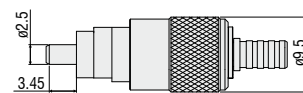

DIN Connector

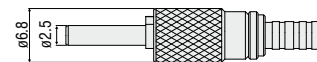

Sensors and Systems from Micro-Epsilon



Sensors and systems for displacement, distance and position



Sensors and measurement devices for non-contact temperature measurement



Measuring and inspection systems for metal strips, plastics and rubber



Optical micrometers and fiber optics, measuring and test amplifiers



Color recognition sensors, LED analyzers and inline color spectrometers



3D measurement technology for dimensional testing and surface inspection