









More Precision

optoNCDT ILR3800-100 // Laser distance sensor



High-performance laser distance sensor for industrial applications

optoNCDT ILR3800-100

-  Large measuring range up to 100 m (150 m with reflector)
-  Ideal for OEM serial integration
-  Laser class 2
-  Highest signal stability on numerous surfaces
-  Compact & lightweight design
- INTER FACE** Analog / USB / RS422 / PROFINET / EtherNet/IP
-  Optionally with integrated heating for outdoor applications



With the optoNCDT ILR3800-100, Micro-Epsilon presents a new powerful laser distance sensor. The sensor is designed for operation with or without reflector film, which is used depending on the distance and ambient conditions. The sensor measures large distances up to 100 m without contact and provides best results even on challenging (dark, structured or weakly reflecting) surfaces. The measuring range can be extended up to 150 m by attaching a reflector film to the measuring object.

Thanks to the integrated AUTO measuring mode, even dark, partially reflective and distant targets can be detected precisely and reliably. A simple and fast alignment of the sensor is made possible by the integrated mounting plate with 4 set screws.

The ILR3800-100 laser distance sensors provide reliable results even under harsh conditions. They are protected against dust and splash water thanks to the robust design in the IP67-certified aluminum housing. Compact size combined with low weight opens up new fields of application particularly in factory and plant automation, as well as in drone applications for distance measurement from the air.

New: ILR3800-100-H with integrated heating

The ILR3800-100-H option has an integrated heating and cooling element that enables operation in the temperature range of -40 to +55 °C. This allows the sensors to be used permanently outdoors.

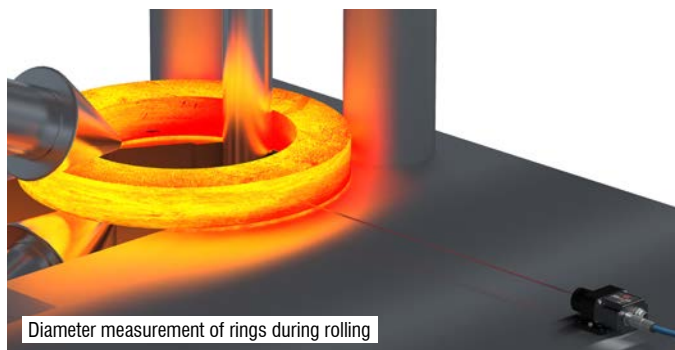
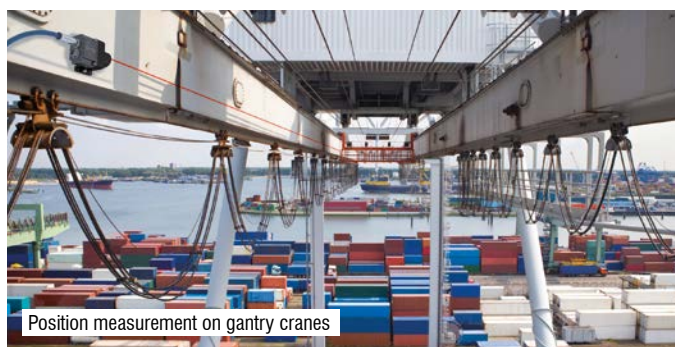

Model		ILR3800-100	ILR3800-100-H
Measuring range ^[1]	Black 6 %	Start of measuring range	0.05 m
		End of measuring range	30 m
	Gray 40 %	Start of measuring range	0.05 m
		End of measuring range	70 m
	White 80 %	Start of measuring range	0.05 m
		End of measuring range	100 m
	Reflector film	Start of measuring range	35 m
		End of measuring range	150 m
Measuring rate		20 Hz	
Resolution		0.1 mm	
Linearity		< ± 1mm ^[2]	
Repeatability ^[3]		< 300 μm	
Temperature compensation		-10 ... +50 °C	-40 ... +55 °C
Light source		Semiconductor laser < 1 mW, 655 nm (red)	
Typ. service life		50,000 h	
Laser class		Class 2 in accordance with DIN EN 60825-1: 2022-07	
Permissible ambient light		50,000 lx	
Supply voltage		10 ... 30 VDC	24 ... 30 VDC
Power consumption		< 1.5 W (24 V)	< 10 W (24 V)
Signal input		Trigger	
Digital interface		RS422 / USB/ PROFINET/ EtherNet/IP ^[4]	
Analog output		4 ... 20 mA (16 bit, freely scalable within the measuring range)	
Connections		Supply/signal: M12 screw/plug connection 8-pin A-coded	
Mounting		Screwing and adjustment on sensor base plate	
Temperature range	Storage	-25 ... +70 °C (non-condensing)	
	Operation	-10 ... +50 °C (non-condensing)	-40 ... +55 °C (non-condensing)
Shock (DIN EN 60068-2-29)		15 g / 6 ms in 3 axes, in 3 directions, 1000 shocks each	
Vibration (DIN EN 60068-2-6)		15 g / 10 ... 500 Hz in 3 axes, 10 cycles each	
Protection class (DIN EN 60529)		IP67	
Material		Aluminum housing and plastic cap	
Weight		207 g	217 g
Control and indicator elements		2x LED for power, signal strength = status	

^[1] Depends on target reflectivity, ambient light influences and atmospheric conditions

^[2] Measured in the range of 0.05 ... 20 m; statistical spread 2 σ

^[3] Measurement frequency of 20 Hz, moving average 10

^[4] Connection via interface module (see accessories)

EtherNet/IP[®] PROFINET[®] Analog RS422

Oval light spot diameter ILR3800-100

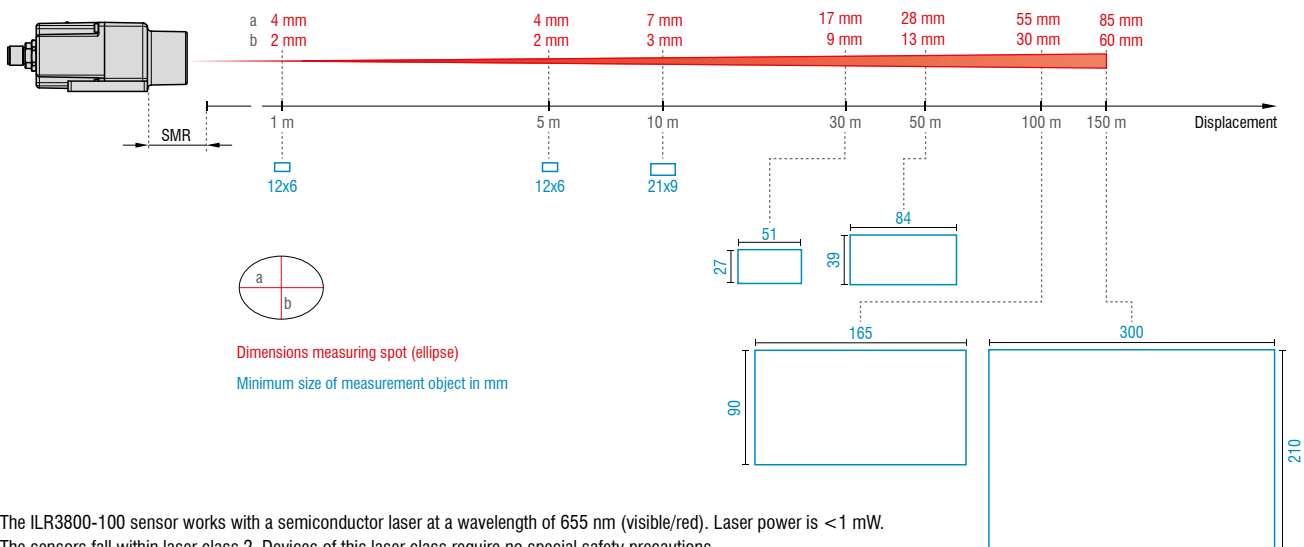

The ILR3800-100 sensor works with a semiconductor laser at a wavelength of 655 nm (visible/red). Laser power is < 1 mW. The sensors fall within laser class 2. Devices of this laser class require no special safety precautions.

Dimensions

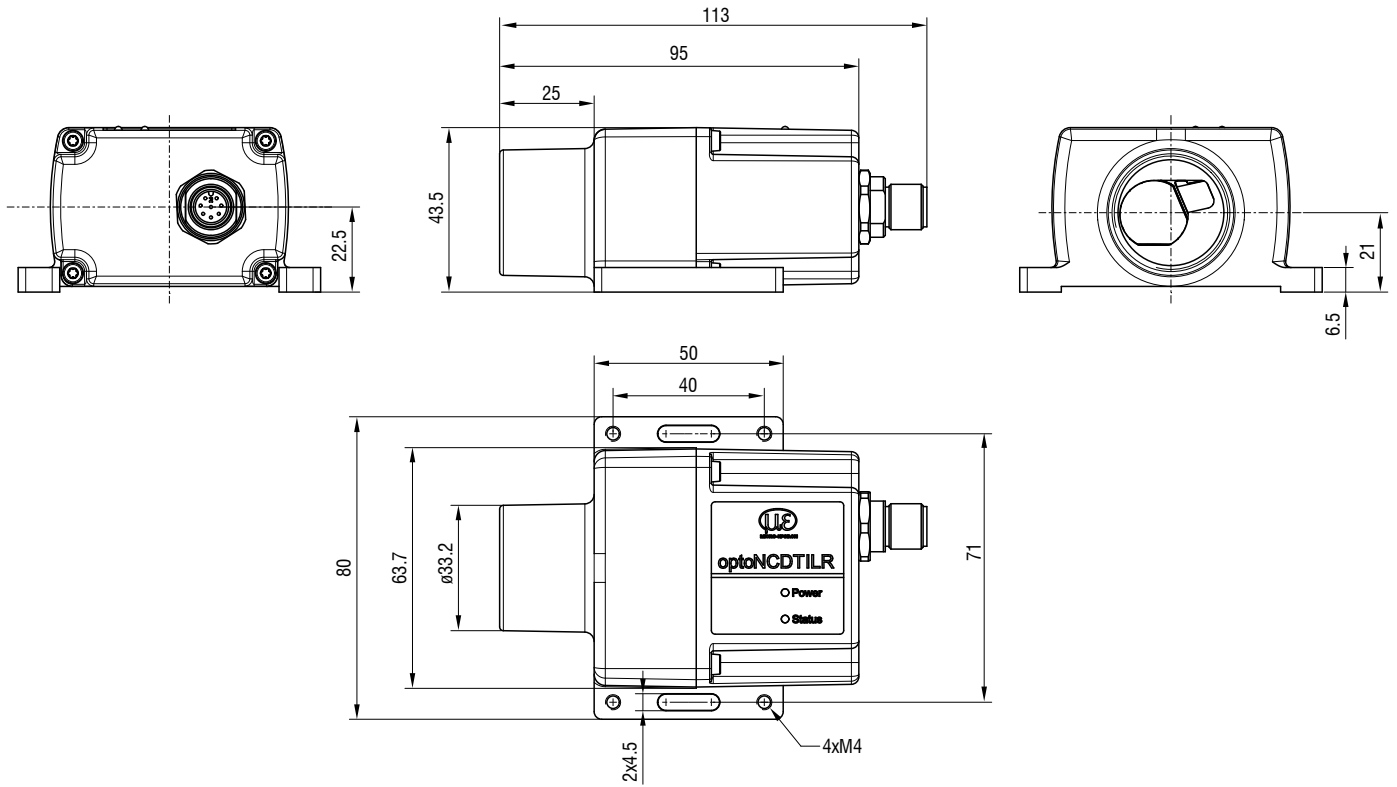

(dimensions in mm, not to scale)