



More Precision







confocalDT IFC241x

Compact confocal controllers for precise distance & thickness measurements



Compact confocal chromatic controllers for industrial series applications

confocalDT IFC2411

-  Most compact confocal controller on the market
-  Nanometer resolution for precise distance and thickness measurements
-  **INTERFACE** Flexible integration via Ethernet, RS422 or analog output (U/I)
-  Direct PLC connection due to Industrial Ethernet
-  **IP40** Robust aluminum housing (IP40)
-  **Preis Leistung** Excellent price/performance ratio



Precision meets compactness – powerful confocal chromatic controllers

The IFC2411 sets new standards in non-contact distance and thickness measurements. Not only is it currently the smallest confocal chromatic controller on the market, it also delivers precise measurement results at high speed. Its unique design allows for the controller to be easily integrated into existing installations and systems. It can be quickly mounted on a DIN rail and fits into even the smallest control cabinets.

Largest sensor selection & numerous application possibilities

The flexible connection of various sensors enables measurements on almost all surfaces as well as one-sided thickness measurements on transparent objects. Micro-Epsilon's extensive sensor portfolio covers measuring ranges from 0.1 mm to 30 mm.

Developed for industry, OEM & automation

Equipped with various interfaces, the controller offers maximum flexibility for integration into machines and systems. A robust IP40 aluminum housing ensures optimum protection even under harsh conditions, so that maximum precision and signal stability can be achieved. The system is particularly impressive in industrial series and OEM applications due to its excellent performance and outstanding price-performance ratio.

Video signal display

Measurement chart

Presets for fast setting

Simple operation via web interface
 Set up and configuration of controller and sensors is handled in a user-friendly web interface via Ethernet connection. No additional software is required. For thickness measurements, materials are stored in an editable materials database.







Model		IFC2411	IFC2411/IE
Resolution	Ethernet	2 nm	-
	Industrial Ethernet	-	2 nm
	RS422	18 bit	
	Analog	16 bits (teachable)	
Measuring rate		Continuously adjustable from 100 Hz to 8 kHz	
Linearity ^[1]		typ. < ±0.03 % FSO (depends on sensor)	
Multi-peak measurement		1 layer	
Light source		Internal white LED	
No. of characteristic curves		up to 10 characteristic curves for different sensors per channel, selection via table in the menu	
Permissible ambient light ^[2]		30.000 lx	
Synchronization		yes	
Supply voltage		24 VDC ± 10 %	
Power consumption		< 7 W (24V)	
Signal input		Sync-in / trig-in; 1x encoder (A+, A-, B+, B-, index)	
Digital interface		Ethernet / RS422	EtherCAT / PROFINET / EtherNet/IP / RS422
Analog output		Current: 4 ... 20 mA; voltage: 0 ... 5V & 0 ... 10 V (16 bit D/A converter)	
Digital output		Sync-out	
Connection	Optical	pluggable optical fiber via E2000 socket, length 2 m ... 50 m, min. bending radius 30 mm)	
	Electrical	3-pin supply terminal block; 6-pin I/O terminal block (max. cable length 30 m); 17-pin M12 connector for RS422, analog and encoder; RJ45 connector for Ethernet) (max. cable length 100 m)	3-pin supply terminal block; 5-pin I/O terminal block (max. cable length 30 m); 17-pin M12 connector for RS422, analog and encoder; RJ45 connector for Industrial Ethernet (max. cable length 100 m)
Mounting		free-standing, DIN rail mounting	
Temperature range	Storage	-20 ... +70 °C	
	Operation	+5 ... +50 °C	
Shock (DIN EN 60068-2-27)		15 g/6 ms on XYZ axis, 1000 shocks each	
Vibration (DIN EN 60068-2-6)		2 g / 20 ... 500 Hz in XYZ axis, 10 cycles each	
Protection class (DIN EN 60529)		IP40	
Material		Aluminum	
Weight		approx. 335 g	
Compatibility		compatible with all confocalDT sensors	
No. of measurement channels		1	
Control and indicator elements		Web interface for setup and settings Multifunction button: interface selection, two adjustable functions and reset to factory settings after 10 s; 4x color LEDs for intensity, range, link and data	Multifunction button: interface selection, two adjustable functions and reset to factory settings after 10 s; 4x color LEDs for Intensity, Range, RUN and ERR

^[1]FSO = Full Scale Output

^[2]Illuminant: light bulb

Powerful confocal controllers for precise and fast inline processes

confocalDT IFC2416

-  Nanometer resolution for highest precision
-  Ideal for extremely fast distance and thickness measurements up to 25 kHz
-  Multi-peak: up to 5 layers with one measurement
-  Best signal quality and stability due to high light intensity
-  Flexible integration via Ethernet, RS422 or analog output
-  Compact design and robust IP40 aluminum housing



High speed and precision in one housing

The IFC2416 confocal chromatic controller is characterized by a high measuring rate of 25 kHz and enormous light intensity, which enables stable and precise measurements at high speed on various materials and surfaces. The compact controller is used for high-resolution distance and thickness measurements in all areas of industry. Thanks to the multi-peak option, multi-layer measurements (up to 5 layers) of transparent objects are possible.

Flexible choice of sensor for a wide range of applications

The controller can be combined with diverse sensors from the Micro-Epsilon portfolio to cover measuring ranges from 0.1 mm to 30 mm.

Robustness and ease of integration

Its compact IP40 aluminum housing optimally protects the powerful controller. It can therefore be easily integrated into machines or production lines in harsh environments.

Several interfaces are available for software integration. In addition to digital output via Ethernet and RS422, analog signals can be output as current or voltage values. Encoder inputs and a synchronization and switching output are available for optimum process control.

Extremely high light intensity:
Stable and fast measurements on all materials and surfaces

Largest sensor portfolio:
Flexible selection of
- Measuring range & offset distance
- Field of application: vacuum, industry, temperature
- Light spot & measuring angle
- Design & beam path (straight/lateral)

One-sided thickness measurements, e.g. of flat glass

Structured surfaces, e.g. metals

Dark surfaces, e.g. rubber

Shiny surfaces, e.g. mirrors

Detection of fine structures, e.g. PCB traces

Optical glasses, e.g. lenses

Model		IFC2416
Resolution	Ethernet	2 nm
	RS422	18 bit
	Analog	16 bits (teachable)
Measuring rate	Continuously adjustable from 100 Hz to 25 kHz	
Linearity ^[1]	typ. < ±0.03 % FSO (depends on sensor)	
Multi-peak measurement	5 layers	
Light source	Internal white LED	
No. of characteristic curves	up to 10 characteristic curves for different sensors per channel, selection via table in the menu	
Permissible ambient light ^[2]	30.000 lx	
Synchronization	yes	
Supply voltage	24 VDC ±10 %	
Power consumption	< 8.5 W (24V)	
Synchronization	Sync-in / trig-in ; 2x encoders (A+, A-, B+, B-, index) or 3x encoders (A+ , A-, B+, B-)	
Digital interface	Ethernet / RS422	
Analog output	Current: 4 ... 20 mA; voltage: 0 ... 5V & 0 ... 10 V (16 bit D/A converter)	
Digital output	Sync-out; error-out	
Connection	Optical	pluggable optical fiber via E2000 socket, length 2 m ... 50 m, min. bending radius 30 mm)
	Electrical	3-pin supply terminal block; 6-pin I/O terminal block (max. cable length 30 m); 17-pin M12 connector for RS422, analog and encoder; RJ45 connector for Ethernet) (max. cable length 100 m)
Mounting	free-standing, DIN rail mounting	
Temperature range	Storage	-20 ... +70 °C
	Operation	+5 ... +50 °C
Shock (DIN EN 60068-2-27)	15 g/6 ms on XYZ axis, 1000 shocks each	
Vibration (DIN EN 60068-2-6)	2 g / 20 ... 500 Hz in XYZ axis, 10 cycles each	
Protection class (DIN EN 60529)	IP40	
Material	Aluminum	
Weight	approx. 460 g	
Compatibility	compatible with all confocalDT sensors	
No. of measurement channels	1	
Control and indicator elements	Web interface for setup and settings Multifunction button: interface selection, two adjustable functions and reset to factory settings after 10 s; 4x color LEDs for intensity, range, link and data	

^[1] FSO = Full Scale Output

^[2] Illuminant: light bulb

Dimensions

confocalDT IFC241x



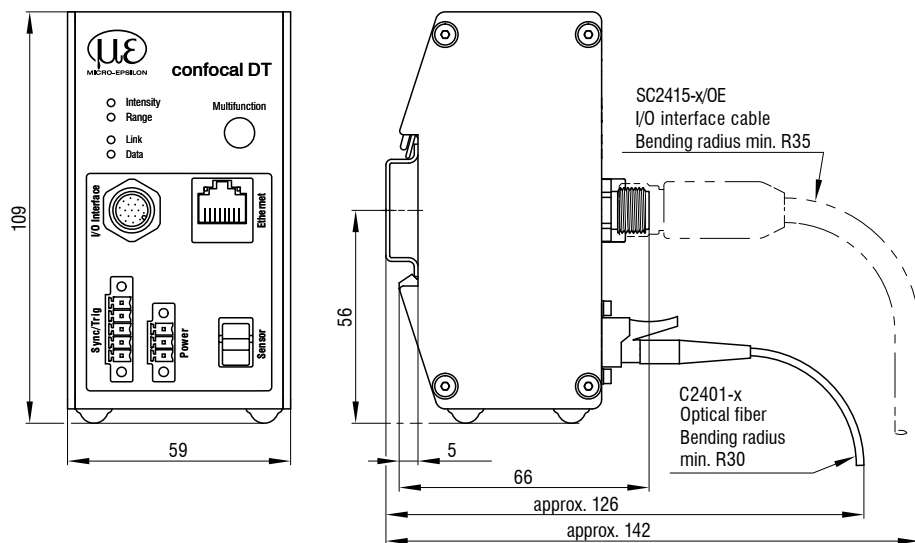

confocalDT IFC2411

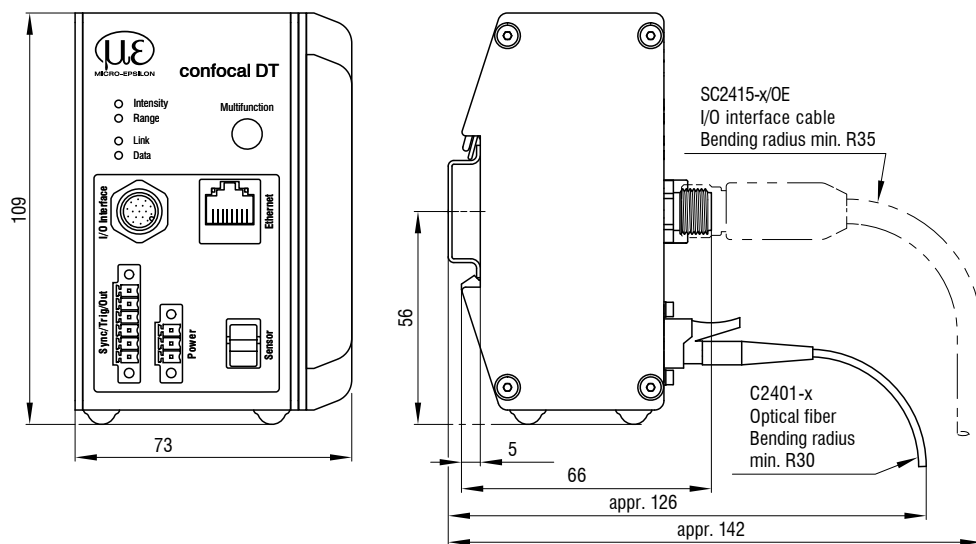

confocalDT IFC2416



Confocal chromatic sensors confocalDT IFS2404

-  Nanometer resolution
-  Smallest light spot
-  Robust aluminum or stainless steel sensors with glass lenses
-  Preis Leistung
Excellent price/performance ratio



Model		IFS2404-1	IFS2404-2	IFS2404-3	IFS2404-6
Measuring range		1 mm	2 mm	3 mm	6 mm
Start of measuring range	approx.	15 mm	14 mm	25 mm	35 mm
Resolution	Static ^[1]	< 12 nm	40 nm	< 40 nm	< 80 nm
	Dynamic ^[2]	< 50 nm	125 nm	< 125 nm	< 250 nm
Linearity ^[3]	Displacement and distance	< ±0.3 μm	< ±1 μm	< ±0.9 μm	< ±1.8 μm
	Thickness	< ±0.6 μm	< ±2 μm	< ±1.8 μm	< ±3.6 μm
Light spot diameter		12 μm	10 μm	18 μm	24 μm
Maximum measuring angle ^[4]		±25°	±12°	±19°	±10°
Numerical aperture (NA)		0.45	0.25	0.35	0.18
Min. target thickness ^[5]		0.05 mm	0.1 mm	0.15 mm	0.3 mm
Target material		reflective, diffuse as well as transparent surfaces (e.g. glass)			
Connection		Pluggable fiber optic cable via FC socket, type CS242-x/CS2401; standard length 2 m; extension up to 50 m; bending radius: static 30 mm, dynamic 40 mm			
Mounting		Radial clamping (mounting adapter see accessories)			
Temperature range	Storage	-20 ... +70 °C			
	Operation	5 ... 70 °C			
Shock (DIN EN 60068-2-27)		15 g/ 6 ms in XY axis, 1000 shocks each			
Vibration (DIN EN 60068-2-6)		2g/ 20 ... 500 Hz on XY axis, 10 cycles each			
Protection class (DIN EN 60529)		IP64			
Material		Aluminum housing, glass lenses	Stainless steel housing, glass lenses	Aluminum housing, glass lenses	
Weight ^[6]		approx. 100 g	approx. 20 g	approx. 100 g	approx. 100 g

^[1] Average from 512 values at 1 kHz, in the mid of the measuring range onto optical flat

^[2] RMS noise relates to mid of measuring range (1 kHz)

^[3] All data at constant ambient temperature (25 ±1 °C) against optical flat; specifications can change when measuring different materials.

^[4] Maximum sensor measuring angle up to which a usable signal can be achieved on reflective surfaces, with accuracy decreasing toward the limit values

^[5] Glass sheet with refractive index n = 1.5 throughout the entire measuring range. In the mid of the measuring range, also thinner layers can be measured.

^[6] Sensor weight without optical fiber

Connection possibilities

